



PDHonline Course R149 (5 PDH)

Engineering Ethics Case Study: The Taum Sauk Reservoir Failure

Instructor: Mark P. Rossow, Ph.D, PE Retired

2020

PDH Online | PDH Center

5272 Meadow Estates Drive
Fairfax, VA 22030-6658
Phone: 703-988-0088
www.PDHonline.com

An Approved Continuing Education Provider

Alfred J. Hendron, Jr.
No. 4 College Park Court
Savoy, IL 61874

Joseph L. Ehasz
11485 Upper Meadow Drive
Gold River, CA 95670

Kermit Paul
15 Boies Ct.
Pleasant Hill, CA 94523

Taum Sauk Upper Dam Breach FERC No. P-2277

Technical Reasons for the Breach
of December 14, 2005

by

FERC Independent Panel of Consultants (IPOC)

Taum Sauk Pumped Storage Project

Alfred J. Hendron, Jr.

Joseph L. Ehasz

Kermit Paul

May 24, 2006

Alfred J. Hendron, Jr.
No. 4 College Park Court
Savoy, IL 61874
94523

Joseph L. Ehasz
11485 Upper Meadow Drive
Gold River, CA 95670

Kermit Paul
15 Boies Ct.
Pleasant Hill, CA

Taum Sauk Upper Dam Breach FERC No. P-2277

Technical Reasons for the Breach
of December 14, 2005

by

FERC Independent Panel of Consultants (IPOC)

Taum Sauk Pumped Storage Project

May 24, 2006

Taum Sauk Upper Dam Breach

Technical Reasons for the Breach of December 14, 2005

Table of Contents

1. Introduction	5
1.1 General	5
1.2 Appointment of Independent Panel of Consultants	5
1.3 Scope of Investigations	6
2. Project Description	7
3. Design, Construction History and Performance	9
3.1 Design and Construction History	9
3.2 Panel Comments on Design	10
3.3 Embankment performance	11
4. Standard Operating Procedure	13
5. Overpumping Protective Systems	14
5.1 Upper Reservoir Water Level Monitoring and Control System As Installed	14
5.2 Emergency Water Level Protection Backup System As Installed	15
5.3 Over Pumping Protection Response on December 14, 2005	16
5.3.1 Response of Water Level Monitoring and Control System	16
5.3.2 Response of Water Level Protection Backup System	17
6. December 14, 2005 Breach	17

6.1 General Descriptions and Observations	17
6.2 Estimate of Peak Reservoir Elevation	18
7. Technical Causes of Breach	20
7.1 Response of Overpumping Protective Systems on December 14, 2005	20
7.2 Upper Reservoir Water Level Monitoring and Control System as Found	20
7.3 Emergency Water Level Protection Back-Up System as Found	25
7.4 Overtopping of Embankment Dam	28
7.4.1 Sensitivity of Taum Sauk Dumped Rockfill Dam to Overtopping	28
7.4.2 Effect of Storing Water on Parapet Wall	30
7.4.3 Foundation of Rockfill Dam	31
7.5 Possible Failure Modes	32
7.5.1 General	32
7.5.2 Discussion of Specific Modes of Failure	33
7.5.3 Comments	34
8. Conclusions	34
Appendix A IPOC Information Request Letter	37
Appendix B Event Chronology	46
Appendix C Early Project Correspondence	64
Appendix D Figures	80

1. Introduction

1.1 General

The upper reservoir of the Taum Sauk Pumped Storage Project (shown full in Figure 1-1) was overtopped during the final pumping cycle the morning of December 14, 2005. Overtopping of the 10 ft high parapet wall and subsequent failure of the rockfill embankment formed a breach about 720 feet wide at the top of the rockfill dam and 430 feet at the base of the dam, as shown in Figure 1-2. Reservoir data indicate that pumping stopped at 5:15 AM December 14, 2005 with the initial breach forming at approximately the same time. Breach widening formed quickly, and complete evacuation of the 4,350 acre-ft upper reservoir occurred within about 25 minutes. The breach flow passed into the East Fork of the Black River (the river upstream of the lower Taum Sauk Dam) through a State park and campground area and into the lower reservoir. Upon leaving the Lower Taum Sauk Dam Spillway area, the high flows proceeded downstream of the Black River to the town of Lesterville, MO, located about 3.5 miles downstream from the Lower Dam, see Figure 1-3. The incremental rise in the river level was about 2 feet which remained within the banks of the river.

1.2 Appointment of Independent Panel of Consultants

This Panel was convened by the FERC Director of Dam Safety to establish an independent assessment of the technical causes of the release of the Upper Reservoir at Taum Sauk. It is anticipated that the conclusions of this report will be applied in the review of other pumped storage projects, which are without spillways on the upper reservoirs and which are within the jurisdiction of the FERC.

Following the breach of the upper reservoir at the Taum Sauk pumped storage project, the Federal Energy Regulatory Commission (FERC) established an Independent Panel of Consultants (IPOC). The individuals on this Panel were contacted by the Director of Dam Safety, Mr. Constantine Tjoumas, during the week of December 26, 2005.

The members of the Independent Panel of Consultants are:

Dr. Alfred J. Hendron, Jr., Geotechnical Engineer
Joseph L. Ehasz, Geotechnical Engineer
Kermit Paul, Mechanical & Electrical Engineer

The Panel members accepted the assignment of investigating the technical causes of this breach; the contractual arrangements were made by the FERC Dam Safety office in Washington D.C.

1.3 Scope of Investigations

In the contractual scope of work for each Review Panel member it was specified that the Panel should:

- Review the operational characteristics of the project including the overpumping protective systems leading up to the breach of the upper reservoir
- Perform a forensic evaluation of the breach of the upper reservoir dam to determine the specific failure mode
- Submit a final report documenting the results of their forensic findings on the cause of the breach of the upper reservoir
- Continue as a panel of experts to assist the FERC staff in reviewing the analysis, design and construction of the remedial measures needed to re-establish the upper reservoir

In this report, the first three bulleted items above are addressed in detail. Reviews of the design and construction of re-establishment of the upper reservoir will be treated in subsequent Panel Reports.

Panel Member Hendron was requested by FERC to visit the Taum Sauk Project on December 14, 2005, before this Panel was appointed. The breach area and the remaining embankment was inspected by Panel Member Hendron on December 15 with FERC staff from the Washington office and from the Chicago Regional Office. Panel Members Ehasz and Paul visited the Taum Sauk site on December 28, 2005. The Panel assembled an initial information request list of 24 items on January 3, 2006 which was necessary to further the Panel's investigation. This list was sent to Mr. Tjoumas on January 6, 2006. This correspondence is given in Appendix A. The Panel received various items of information for review during January and Panel Members Paul and Hendron visited the Taum Sauk Project again on January 30 as part of the First meeting of the AmerenUE Board of Consultants at the site and in St. Louis between January 30 and February 1.

As part of this investigation the Panel held interviews of AmerenUE staff and AmerenUE subcontractors at the project site and in St. Louis on February 8, 9, and 10. Similar interviews of FERC Chicago and Washington D.C. staff and the

authors of the 2003 Part 12 Report were also held in the Chicago Regional office on February 17th, 2006.

The Panel participated in the AmerenUE Board of Consultants Second meeting in St. Louis on March 23 and 24. On March 24, the Panel also received presentations concerning the Taum Sauk site and breach from the Missouri DNR, Division of Dam Safety, and the Geological Survey. The Rizzo forensic report for AmerenUE was received on April 10, 2006 and the Finding Investigation conducted by FERC staff was received on April 25, 2006.

In the remainder of this report, the Panel has described the conditions which existed at the Upper Taum Sauk Reservoir prior to the reservoir release and we have given our conclusions on the most probable causes of the reservoir release at the breach location.

2. Project Description

The Taum Sauk Project is located in Reynolds County, Missouri, on the East Fork of the Black River approximately 90 miles southwest of St. Louis, Missouri. The project is a reversible pumped storage project used to supplement the generation and transmission facilities of AmerenUE, and consists basically of a mountain ridge top upper reservoir, a shaft and tunnel conduit, a 450-MW, two-unit pump-turbine, generator-motor plant and a lower reservoir. It was the first of the large capacity pumped-storage stations to begin operation in the United States. The Project was completed in 1962 and the first filling of the Upper Reservoir began in July 1963. The plant went into commercial operation on December 20, 1963. The operating head between the Upper and Lower Reservoir ranges from 776 ft to 860 ft.

New pump/turbine runners were installed in 1999 resulting in a maximum pumping flow of 3,000 cfs per unit compared to a design flow of 2,450 cfs per unit for the original runners. The upper reservoir has a capacity of 4,350 acre-ft. There is no upper reservoir spillway.

The Upper Dam is a continuous hilltop dike 6,562-ft long forming a kidney-shaped reservoir as shown in Figure 1-1. The dike is a concrete-faced dumped rockfill dam (CFRD) from the foundation level to elevation 1570.0 ft and a rolled rockfill between Elevations 1570 and 1589. The upstream slope is 1.3:1 (horizontal:vertical) and the downstream slope is at the natural angle of repose of the material, approximately 1.3:1, as shown in Figure 2-1. The crest is 12- feet wide. A 10-foot high, 1-foot thick reinforced concrete parapet wall atop the fill extended the crest to elevation 1,599 feet, as originally constructed. Since 1963, the settlements of the rockfill embankment at various points have varied between 1 to 2 feet; the low point at the top of the parapet wall, as surveyed by AmerenUE on November 6, 2004 was elevation 1596.99 feet at Panel 72.

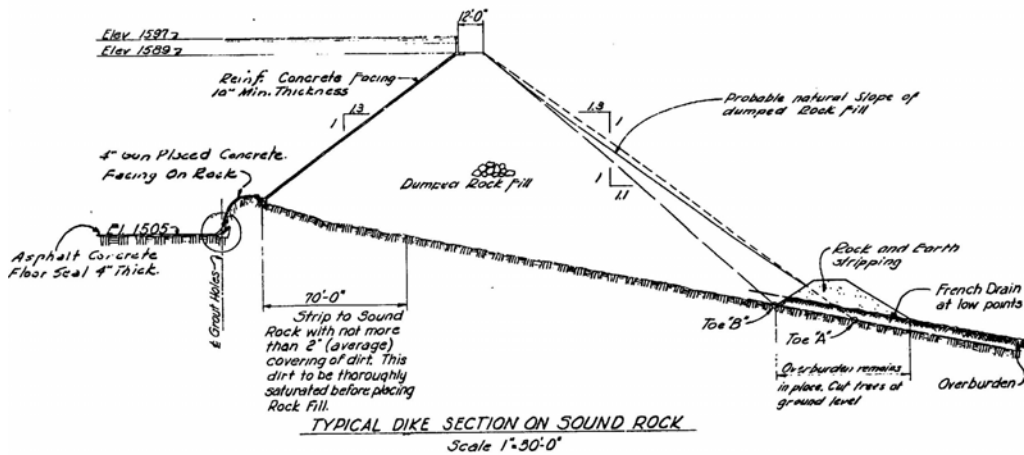

Figure 2-1 Cross section from original design drawings

The pneumatically placed upstream reinforced concrete face slab has a design thickness of 10 inches, and had joints (with copper waterstops) located at the junctures with the parapet wall, the foundation cutoff-slab and with adjacent face panels. The face slab was placed in panels, 60 feet wide at their widest dimension.

The project license was issued on August 26, 1965. The licensee is AmerenUE with headquarters in St. Louis, MO. Taum Sauk is the only pumped storage facility in the AmerenUE system. It is dispatched from the St. Louis control center based on economics and the need to meet requirements of the Mid-West Independent System Operator (MISO) and the Northeast Electric Reliability Council (NERC).

AmerenUE's St. Louis control center staff provide generate mode and pump mode start, stop and generating Megawatt (MW) instructions to operators at Osage control center (Bagnell Dam). In the pumping mode, input MW and pump cfs (cubic feet per second) discharge depend on the head (elevation difference between the upper and lower reservoirs) and are not adjustable. The Osage operators remotely start, stop and load the Taum Sauk units as instructed. Protection circuits are provided at Taum Sauk to prevent operating the units or reservoirs beyond established limits.

Over-pumping protection of the upper reservoir consists of two separate systems, the water level monitoring and control system and the emergency level protection backup system. These over-pumping protection systems were initiated into operation in November of 2004 in conjunction with the installation of a geomembrane liner to reduce reservoir leakage. As part of this "project improvement" the old reservoir control systems which were anchored to the concrete face prior to 2004 were replaced by the new system in November of 2004. The new system was not anchored to the concrete face because it was

decided that the new geomembrane liner should not be penetrated by anchor bolt holes. The HDPE pipe housing the pressure instruments was not positively anchored to the concrete face slab.

3. Design, Construction History and Performance

3.1 Design and Construction History

The top of Proffit Mountain was leveled and the excavated rock was used to construct the dike that forms the upper reservoir. The bedrock and thus the rockfill is predominantly a rhyolite porphyry. Little information is available concerning the as-built gradation of materials used in the construction. As described in available engineering reports, the overburden was stripped for the upstream-most 70 feet, as shown in Figure 2-1, and placed downstream to form the bed of the perimeter road. All weathered material was to be stripped from this area to sound rock. Overburden varied from a few feet to as much as 65-feet thick. Clay seams were also removed by excavating during construction. Excavated rock was end-dumped from trucks and sluiced with 30-psi water, to form the ring dike. A filter zone and several layers of compacted rock were placed over questionable areas where piping into the foundation might be possible. Outside of the 70-foot stripped zone, the weathered rock was left in-place. Low areas in the natural topography were also filled with compacted rock. It was reported in the 7th Part 12D report that excavated fines were used to level the reservoir floor.

The upstream slope is 1.3:1 (horizontal: vertical) and the downstream slope is at the natural angle of repose of the material, approximately 1.3:1. The pneumatically placed upstream concrete face slab has a design thickness of 10 inches, and is reinforced with No. 7 bars at 12 inches both ways. In actual placement, the slab thickness averaged nearly 18 inches due to the unevenness of the rockfill. The upstream concrete face had joints (with copper waterstops) located at the junctures with the parapet wall, the foundation cutoff-slab and with adjacent face panels. The face slab was placed in panels, 60 feet wide at their widest dimension. Expansion joints between the slabs to accommodate movement, caused by settlement of the rockfill, used ¾-in asphaltic expansion joint material and U-shaped copper water stops.

A reinforced concrete plinth was provided at the toe of the concrete face. Where the natural rock surface was substantially higher than the reservoir floor, the rock was excavated on a near vertical slope and the plinth was at the top of the excavated rock. In these areas, the rock cut between the reservoir floor and the plinth was sealed with a 4-inch layer of wire mesh-reinforced shotcrete. The entire reservoir bottom was sealed with two-2-inch layers of hot-mix asphalt concrete placed over leveled and compacted quarry muck. Around the edge of the asphaltic concrete, a single line grout curtain was constructed to limit seepage under the dam.

The ring dike forming the Upper Reservoir was closed near panel 50, which is also an area of reportedly finer materials. The dike is topped with a 12-foot layer of horizontally compacted rock placed in 4-foot lifts and compacted with a vibratory roller. The parapet wall was cast-in-place on top of this top layer. Based on observation, it appears the crushed rock varies from 1000 lb stone to predominately less than 20 lb stone. The stone is predominately angular. The outer shell of the dike contains clean rock fill material with more sandy and pebble sized materials in the closure section. Settlement of the rockfill varied between 1 and 2 ft. with the lowest area at Panel 72, where the top of the parapet wall was 1596.99 ft as determined by an AmerenUE survey dated November 6, 2004.

3.2 Panel Comments on Design

The design and construction of the CFRD for the Taum Sauk Upper Reservoir Dam followed the pattern of older CFRD's constructed in California such as Strawberry Dam and Salt Springs Dams. These dams were dumped rockfill CFRD's with slopes ranging from 1.3:1 to 1.4:1. Each of these dams have parapet walls for reflecting waves at normal maximum water storage level; but the maximum water storage levels are always about 1 to 2 ft below the crest of the rockfill. But water levels could possibly encroach on the parapet walls in times of floods. The design decision made for Taum Sauk Upper Reservoir Dam to routinely store water 6 to 8 ft high on a 10 ft high parapet wall during daily operations made the Taum Sauk dumped rockfill CFRD "Unprecedented" as compared to the previous CFRD's, as summarized by Cooke, 1988 (Figure 3-1).

It is noted from Figure 3-1 that nearly 100% of the CFRD's prior to 1963 were dumped and many had cracked face slabs and high leakage. Because of this behavior there were no CFRD's built between 1940 and 1950. As shown on Figure 3-1 Taum Sauk was the last newly constructed dumped rockfill CFRD in the USA; it is also shown in Figure 3-1 that Cabin Creek CFRD was designed at about the same time, but was designed as a compacted rockfill CFRD. Cabin Creek was compacted in 2 ft thick lifts to a height of 70 m (230 ft.) and was an Upper Reservoir Dam for a pumped storage project in Colorado. The maximum section of Cabin Creek Dam is shown in Figure 3-2 which shows an upstream slope of 1.3:1 and a downstream compacted slope of 1.75:1. It is especially important to note that the maximum operating level is 6 ft below the rockfill crest of the dam, and 9 ft below the top of a 3 ft high parapet wall on the crest of the dam. The differences in the Taum Sauk and Cabin Creek CFRD designs represent differences in risk tolerances for different engineering firms and individual consultants during the same time frame taking into account the state of the art for CFRD design in the middle 1960's. It should also be noted that Cabin Creek Dam was overtopped by pumping, but did not fail.

3.3 Embankment Performance

As described above in Section 3.1, the embankment is a rockfill structure with a parapet wall and has experienced considerable deformation and settlement beginning with the first filling of the reservoir. For example, there were settlements in excess of one foot within the first two years of operation (1963 – 1965). These settlements continued, although at a lower rate, until 1976, when they leveled somewhat, to as much as 1.6 feet of settlement along the NW sections of the embankment. See Figure 3-3 for the movements of settlement points 1 through 23. The plan location of these points are shown on Figure 3-4. The last survey data shown from January 2004 indicates that the settlements have not increased since 1987, and any changes over the past 20 years appear to be within the accuracy of the surveys.

In late 1963, only several months after first filling, major repairs were necessary along the interior of the NW section of embankment, upstream of Panels 91 and 92. These repairs consisted of excavation, grouting, developing a concrete cut-off, and joint repairs. Throughout the following several years additional repairs were continued to control leakage and distress to the embankment and foundation as well as the face slabs and parapet walls. As can be seen on the plot of crest settlement, Figure 3-3, as well as variations in the top of the parapet wall shown on Figure 3-5, "Crest Survey Data", surveyed along the dam and parapet wall after the breach, there were significant elevation differences along the crest of the parapet wall. There were areas such as those at parapet Panel No. 72 with elevations as low as El 1597 and several other panel areas ranging in elevations from EL 1597 to 1598. Also shown on Figure 3-5 are elevations of the top of the parapet wall for Panels 69 through 75, as surveyed by AmerenUE on November 6, 2004.

The leakage from the Upper Reservoir has been a continuing problem and concern beginning in September 1963. As an example, during that time a sudden increase in seepage to 103 cfs was experienced and emergency measures were taken to repair with concrete plugging in two holes in the floor at panels 91 and 92. Three days later, another episode of increased leakage caused another shut-down and repair. The repair consisted of excavating a 230 ft. long by 4 ft. wide trench, excavated to "rock" and backfilled with concrete at Panels 90 to 93 and 95. A number of repairs were made throughout subsequent years focusing more on leakage through the horizontal and vertical joints in the concrete facing. Particular emphasis was on the joints between the concrete facing and bedrock, the joint at the toe of the parapet section, and the joint between the concrete facing and plinth. Higher rates of leakage (40 to 100 cfs) began in 1999 following an extended outage. It is shown in Figure 3-6 that the leakage increased significantly after 1999 as the plant was used more extensively after replacing the runner and increasing the Plant efficiency. Thus, the project suffered from several episodes of seepage concerns throughout its history. The effects of all of the leakage on the embankment cannot be exactly

determined; however, it surely had an effect on increasing the settlement up to 1987 and potential movement of materials. A geomembrane liner was subsequently installed in 2004, which significantly reduced the leakage to about 5 cfs for the 12 months prior to the breach. Figure 3-6 shows the history of leakage and the periods of repairs. A chronology of events dating from submittal of the geomembrane liner design in January 2002 through the breach event of December 14, 2005 is given in Appendix B, which is taken from the FERC Report of Findings on the Taum Sauk Upper Dam Failure.

Thus, the Upper Reservoir Embankment has had a long history of settlement and high underseepage. Its performance as an effective water barrier was difficult to gage, since it has, in-fact, performed over the past 42 years. Although there were many periods of concern and needed repair to keep the water within the reservoir, the embankment and parapet wall did function as the containment for the Upper Reservoir. The rockfill embankment, as discussed in Section 3.1, was a steep dumped rockfill and the storage of water on the high parapet wall was unprecedented. There was most likely no margin for additional loading or overtopping, as was the case with the breach on December 14th. The holes which developed on the upstream side of Panels 90-95 in the 1963-1964 time frame suggested that the plinth was not extended to rock in that area, as should have been done, for a normal CFRD constructed in the middle 1960's. As discussed in Section 6, Figures 6-5, 6-6, and 6-7 indicate that the actual plinth was not extended down to rock. Early project correspondence by J.B. Cooke, M.W. Fler, Raymond Weldy and an unknown Union Electric employee are given in Appendix C, which refer to early behavior of the Upper Reservoir and the possible resistance to erosion in the event of overpour over the parapet wall.

Horizontal misalignment of joints in the parapet wall in the area of the breach were noted in the 1967 Safety Report and in the 2003 Safety Report as given below.

In the August 19, 1967 Report on Safety, Mr. Cooke cites offsets in March 1966 on the order of 1/4 inch with several joints near Panel 88 at 1 to 1.5 inches.

In the 2003 Part 12D Report, the consultant states horizontal movement included rotation and translation of the wall joints. The report states:

“The maximum horizontal movement observed was at joint 89/90 and 106/107, with about 4-5 inches of translation and rotational movement. --- panel 90 having moved downstream relative to panel 89. The copper waterstop was visible in the joint. This magnitude of movement is likely sufficient to tear the waterstop, but probably does not affect the wall stability.”

4. Standard Operating Procedure

The Taum Sauk project is a peaking and emergency reserve facility. A typical daily cycle in the summer is to generate in the morning by releasing water from the upper reservoir through the pump/turbines to the lower reservoir, pump from the lower reservoir to the upper reservoir in the afternoon, generate in the evening and pump from the lower reservoir to the upper reservoir in the early morning. Generation and pump-start and duration is determined by system needs and controlled from AmerenUE's Osage Plant. In the fall, winter, and spring, the number of cycles is typically less, usually pumping at night and generating during the day. At times, during periods of low demand, the facility is not operated.

The project is controlled through a microwave system from the Osage Plant at the Lake of the Ozarks, under the direction of the load dispatcher in St. Louis. Both units can be put on full load in a few minutes.

Normal automatic settings before the installation of the membrane liner were:

	UPPER RESERVOIR ELEVATIONS		LOWER RESERVOIR ELEVATIONS
	Summer [feet]	Winter [feet]	All seasons [feet]
1 st pump OFF	1595	1588	739
2 nd pump OFF	1596	1589	736.2
All pumps OFF	1597	1590	736

After the installation of the liner and new reservoir level measuring instruments in 2004, but before October 2005, the 1st pump off and 2nd pump off were Elev. 1594 and 1596, respectively. After October 2005, the first pump was to be shut down at the indicated Elev. of 1592 and automatic shutdown of the 2nd pump at Elev. 1594. At Elev. 1594.2, automatic shutdown for both pumps was to be initiated if they were not shutdown already. The 2 ft. lowering of the shutdown elevations for the pumps in October, 2005 was initiated by AmerenUE because movements of the protective pipes housing the pressure transducers in the reservoir was noticed as early as October 7, 2005. This is discussed in more detail in Section 7.2

5. Overpumping Protective Systems

5.1 Upper Reservoir Water Level Monitoring and Control System As Installed

Originally, the upper reservoir water level monitoring and control system used a floating “skate” for water level monitoring and float operated switches for emergency backup pump shutdown and alarm. In 2000, the original skate system, encoder, and chart recorder were replaced with a differential pressure level transmitter, Programmable Logic Controller (PLC), and a digital level indicator at the upper reservoir. As part of the upper reservoir liner project in 2004, all of the earlier systems were replaced with pressure transducers for water level monitoring and control and conductivity probes for emergency backup pump shut down and alarm.

The 2005 water level monitoring and control system uses three 0-100 psi pressure transducers lowered into the reservoir to approximately Elev. 1500 and enclosed in a protective HDPE pipe. These transducers produce an electrical signal proportional to pressure. The three electrical signals are converted to pressure (feet of water) and then into upper reservoir water surface level. All three signals are sent to Taum Sauk power plant, Bagnell Dam control center and St. Louis control center where their average value is displayed as reservoir water level and is also used to calculate volume display values. Individual level signals from the transducers can also be displayed at these locations.

A programmable logic controller (PLC) automatically initiates shut down of the first pump at an indicated water level of Elev. 1592 and automatic shut down of the second pump at Elev. 1594. At Elev. 1594.2, automatic shut down is initiated for both pumps if they have not shut down already. Prior to October 2005, the pump shutdown levels were Elev. 1594 and Elev. 1596 respectively. The reason for these level changes is discussed in Section 7.

There is also a penstock pressure gauge (transducer) located in the power plant which can be used to provide an indication of upper reservoir water level during static conditions. This instrument is not used for this purpose during operation of the pump/turbines since a correction would be needed to account for velocity head and head loss in the water conduit to the upper reservoir. In addition, the pressure range of the penstock gauge (transducer) is about 900 feet compared to about 235 feet for the upper reservoir pressure transducers. Since the accuracy of pressure gauges and transducers is typically given as a percent of full scale reading, the penstock pressure gauge (transducer) is not as accurate as the upper reservoir pressure transducers for determining water level.

An upward adjustment of 0.4 ft. to the pressure transducer readings was made in the PLC code on September 27, 2005 in response to visual observation of reservoir level at Panel 72 compared to transducer indications. In addition, on October 7, 2005, lateral displacement of the transducers protective pipe was

observed. AmerenUE staff recognized that the transducer displacement was producing reservoir level indications lower than actual levels. In response, the pump automatic shutdown level was lowered from Elev. 1596 to Elev. 1594 “_____ so that we won’t pump over the reservoir walls.” (a quote from internal correspondence).

5.2 Emergency Water Level Protection Backup System As Installed

This system, commissioned in the fall of 2004, uses five Warrick conductivity probes with associated relays. Figure 5-1 is a diagram of the system as designed (11/01/2004). One of the probes is placed near the bottom of the upper reservoir and serves as the reference probe for the other four probes. The Hi and the Hi-Hi probes were placed at Elevations 1596.0 and 1596.2 respectively in November 2004. The top of the parapet at the probe location is Elev. 1598.

When water reaches the Hi probe, a circuit is completed through the water to the reference probe or other grounded metal objects to operate the associated Hi relay. A similar circuit is completed when the water reaches the Hi-Hi probe to operate the associated Hi-Hi relay. The remaining two conductivity probes, Lo and Lo-Lo, are located near the reservoir bottom and are used for backup shutdown in the generating mode of operation to prevent vortex formation at the intake or draining of the reservoir.

As shown in Figure 5-1, operation of either the Hi relay or the Hi-Hi relay provides a signal to the plant to stop the pumps and activate an alarm. AmerenUE reported that the Hi and Hi-Hi probes were tested at commissioning in the fall of 2004 as follows:

“First, the probes were circuit-checked to ensure that they would activate the pump shutoff signal and the alarm. Second, the probes were placed in water to simulate their operation in the upper reservoir. The pump shutoff signal at the plant was concurrently monitored to verify that the probes properly activated the pump shutoff signal and alarm when the probes were placed in water. Third, once the upper reservoir was filled, the Hi and Hi-Hi probes were immersed in the reservoir to confirm that the probes properly activated the pump shutoff signal and alarm.”

In December 2004, the PLC logic was changed so that both relays had to be energized for sixty seconds to provide a signal to stop the pumps and activate an alarm. In addition, both the Hi and Hi-Hi probes were reportedly raised to Elevations 1596.7 and 1596.9 respectively as shown on Figure 5-2. These changes were documented in comments within the PLC code and as revision 15 to drawing 8303-P-26648.

During the post-breach interview process, AmerenUE’s Vice President of Power Operations expressed the opinion that the Hi and Hi-Hi probes may never have

been set at Elevations 1596.7 and 1596.9 as recorded on electrical drawing 8303-P-26648 Rev. 15 and as noted in comments in the associated PLC program. He noted that the probe cables had only two tape bands on each one and that they were separated by 18 inches, the distance between the original probe elevations and the final as found elevations.

The tape bands were apparently used to reference the probe elevation with respect to the top of the protective pipe. There were no marks on the cables to indicate that the probes were ever set at intermediate elevations. The question of when and why the Hi and Hi-Hi probes were raised to the post-breach as found elevations is an interesting one, but it does not affect the analysis of the cause for the reservoir breach.

The alarm output is initiated by the Hi-Hi- probe and not the Hi probe. This is contrary to normal alarm and trip practice which gives an alarm first followed by a trip if the parameter being measured continues changing in an unsafe direction. Vibration, pressure, level, and temperature are parameters that are often monitored by two sensors; one to provide an alarm function and the second to provide the trip or shutdown function.

Figure 5-3 (02/15/2005) shows a logic change requiring both, rather than either, the Hi and the Hi-Hi probe to be wet for sixty seconds in order to initiate a pump shutdown.

5.3 Overpumping Protection Response on December 14, 2005

5.3.1 Response of Water Level Monitoring and Control System

As noted above, both units were in the pumping mode in the early morning of December 14, 2005. At 04:39, Unit #2 was shut down automatically at an indicated upper reservoir water level of Elev. 1591.6. At 05:15, Unit #1 was shut down manually by the Bagnell Dam control center operator in accordance with instructions from St. Louis control center to shutdown just shy of where it would shut down automatically (Elev. 1594). At that time, the reservoir level reading was Elev. 1593.7. The automatic shut down of the first pump and the non-automatic shut down of the second pump is consistent with level information from the pressure transducers and the automatic shut down elevations described above.

Since the reservoir overtopped and the top of the parapet wall at its lowest point is at Elev. 1597, it is clear that the actual water level exceeded the indicated Elev. 1593.7 and that the pressure transducer signals were in error.

5.3.2 Response of Water Level Protection Backup System

No shutdown or alarm was produced from the conductivity probe backup system on December 14, 2005.

6. December 14, 2005 Breach

6.1 General Descriptions and Observations

On December 14, 2005, an uncontrolled release of water from the upper reservoir occurred at the Taum Sauk Pumped Storage Project resulting in the damage shown in Figures 6-1 and 6-2. The time history of the reservoir transducers and the penstock transducer just before, during, and after the breach is shown in Figure 6-3. It is shown on Figure 6-3 that the full breach developed within about 25 minutes from the initial dropping of the reservoir level.

The upper reservoir of the Taum Sauk Pumped Storage Project was overtopped during the final pumping cycle the morning of December 14, 2005. Overtopping of the 10 ft high parapet wall and subsequent breach of the rockfill embankment formed a breach about 720 feet wide at the top of the rockfill dam and 430 feet at the base of the dam. Reservoir data indicate that pumping stopped at 5:15 AM December 14, 2005 with the initial breach forming at approximately the same time. Breach widening formed quickly, and complete evacuation of the 4,350 acre-ft upper reservoir occurred within about 25 minutes. The breach flow passed into the East Fork of the Black River (the river upstream of the lower Taum Sauk Dam) through a State park and campground area and into the lower reservoir as shown Figure 1-3. Upon leaving the Lower Taum Sauk Dam Spillway area, the flows proceeded downstream of the Black River to the town of Lesterville, MO, located about 3.5 miles downstream from the Lower Dam. The incremental rise in the river level was about 2 feet which remained within the banks of the river.

During IPOC inspections at the site, a good cross-section of the embankment could be observed on the north side of the breach as shown in Figure 6-4. In Figure 6-4 the dumped rockfill can be observed below the upper 20 ft of compacted rockfill. The rockfill exposed in this section is dirtier than a normal rockfill and as such would be more erodible and would be less free draining than a normal rockfill. In fact Dr. Frank Nickell (one of the original consultants during design) mentioned in one of his reports that the rockfill with the most fines could be used in the upper 20 ft of compacted rockfill for the roadway on the outside of the parapet wall.

A residual soil zone of weathered rhyolite could also be observed in the breach area; and one location is shown in Figure 6-4. The residual soil was observed to

be clayey and it was judged to have an effective shear strength almost dictated by the clay portion of the soil. Exposed rhyolite bedrock is also observed in Figure 6-4 as well as the remnants of the lower face slab and plinth.

A closer view of the exposed rhyolite bedrock and residual soil is shown in Figure 6-5. This photo is taken looking east and the rather flat looking joint surface in the rhyolite dips toward the camera in a westerly direction. This discontinuity was observed in the field to dip nearly west at a dip of about 10° . This discontinuity is described as Fracture Set 8 (FS-8) in the Rizzo Report and is reported to have a dip of 8° and a dip azimuth of 270° . As a result of the observation of the residual soil, the IPOC requested that samples of the residual soil be taken for direct shear testing.

The general geology of the breach area is given in the FERC Report and in the Rizzo Report on the Taum Sauk failure. The general geology is not repeated here but it is important to reiterate the most important engineering geology feature associated with the foundation of the Upper Dam. The low dipping joint surface shown in Figure 6-5 is important in that it serves to give a foundation discontinuity which daylight to the west side of the embankment and gives a foundation that in general dips downhill at about $8-10^{\circ}$ in the direction of the applied water forces. In addition some of these joint surfaces appear to have clay coatings. The residual soil from weathering of the rhyolite also presents a zone of weakness as the relic rock structure present yields zones of preferential weakness along the orientation of the flat joint set described above. This can yield a situation where the residual soil left in the foundation of the dam would control the stability of the embankment rather than the shear strength of the rockfill.

Figures 6-6, 6-7, and 6-8 show three views of the area under the base of the bottom of the face slab and plinth. The most glaring issue revealed by Figure 6-6 for example is that it appears that the plinth was not taken down to the rhyolite bedrock shown at the bottom of the photo. This is not considered good practice today and it was not good practice in 1963. Figures 6-7 and 6-8 show similar construction along the plinth area. This observation makes it consistent to rationalize the blow outs and holes that had to be repaired upstream of Panels 90-95 in 1963 and 1964. It definitely appears from these inspections that the plinth was not extended to bedrock for this dam, at least in the breach area.

6.2 Estimate of Peak Reservoir Elevation

A post breach survey by KdG is shown in Figure 3-5 and in Figure 6-9. These figures show the breach area including Panels 88 through 99. The survey indicates that there are 4 areas where there is evidence of overflow. These areas include:

Panels 10, 11, 12
 Panels 88 to 103
 Panels 43 to 56
 Panels 69 to 74

Taking into account the elevations of the end panels in each overflow group from Figure 3-5 it appears as if the maximum reservoir level could range between Elev. 1597.7 and 1597.9.

Another independent estimate of the maximum reservoir elevation reached can be obtained from a comparison of the reservoir levels measured by the pressure transducers in the reservoir and by the penstock reservoir transducer on December 13 and 14, 2005. It was shown for the months of January, February, and March of 2005 that both the reservoir and penstock readings in these winter months were very close to each other and read very close to 1596 when the reservoir was full. The following readings were indicated on December 13th and 14th.

<u>Date</u>	<u>Time</u>	<u>Level Reservoir Transducer</u>	<u>Level Penstock Transducer</u>
12/13/05	5:50	1591.68	1595.88
12/13/05	7:20	1581.52	1585.71
12/14/05	5:15	1593.70	-----

It is noted the readings at 5:50 AM on December 13th show the penstock readings to be 4.2 ft. higher than the levels from the reservoir transducers just after the reservoir had been pumped full. At 7:20 AM on December 13, 2005 the penstock readings were also 4.2 ft. higher than the reservoir readings after the reservoir was drawn down about 10 ft. and held. On December 14th at 5:15 AM the maximum reservoir level indicated by the reservoir transducers was 1593.7 and at that time the last pump had just shut off and the penstock reading was still affected by transients. But if on the basis of past readings, if it is assumed that during the winter months that the penstock reading is near correct and that on the 13th and 14th of December that the reading of the reservoir transducers were about 4.2 ft too low, as established on the December 13th readings, then the maximum reservoir level could have been $1593.7 + 4.2 = 1597.90$ ft.

Since the Hi-Hi Warrick Probe is set at Elev.1597.70 and did not shut the units down, it is most likely that the highest reservoir elevation did not rise greater than 1597.70.

If it is noted that the original survey pins 18 and 19 (Figure 3-4) correspond to Panels 90 and 95 within the breach area and it is shown on Figure 3-3 that the 2004 elevation of Pin 18 and Pin 19 are 1587.5 and 1587.4, respectively. Then

the top of the wall at Panels 90 and 95 were 1597.5 and 1597.4, respectively, which would give overtopping of 0.2 ft and 0.3 ft respectively at these locations. The overtopping depth of Panel 72 would have been 1597.7 minus 1597.0, or 0.7 ft for a maximum reservoir level of 1597.7 ft.

Thus it is indicated that the depth of flow over the wall at Panel 72 was about 2 to 3 times the depth of flow over Panels 90 and 95 in the breach area. The fact that the breach occurred between Panels 88 and 99 could be due to variations in rockfill. It is interesting to note a letter from Mr. M. W. Dille on May 23, 1970. In this letter he summarizes some recent erosion due to rains, by saying that: "There were several small washes noted in the fine fill area between Panels 88 through 110." He also analyzed weir gage readings and noted that: "The gage readings are generally down while the leakage is up. The "fish pond" area, say between Panels 90 and 102 is up in leakage."

These comments, in general, indicate an awareness that this area was more sensitive than other areas of the embankment. The comments also indicate that the rockfill could be finer between Panels 88 and 110 than for other areas of the embankment.

7. Technical Causes of Breach

7.1 Response of Overpumping Protective Systems on December 14, 2005

As noted above, both units were in the pumping mode in the early morning of December 14, 2005. At 04:39, Unit #2 was shut down automatically at an indicated upper reservoir water level of Elev. 1591.6. At 05:15, Unit #1 was shut down manually by the Bagnell Dam control center operator in accordance with instructions from St. Louis control center to shutdown just shy of where it would shut down automatically (Elev. 1594). At that time, the reservoir level reading was Elev. 1593.7. The automatic shut down of the first pump and the non-automatic shut down of the second pump is consistent with level information from the pressure transducers and the automatic shut down elevations described above.

Since the reservoir overtopped and the top of the parapet wall at its lowest point is at Elev. 1597, it is clear that the actual water level exceeded the indicated Elev. 1593.7 and that the pressure transducer signals were in error. No shutdown or alarm was produced from the conductivity probe backup system on December 14, 2005.

7.2 Upper Reservoir Water Level Monitoring and Control System as Found

Following the reservoir failure, the pressure transducers were removed from their protective pipe and re-calibrated. The pressure transducers in service on December 13-14, 2005 are identified as TX2 and TX3. TX1 had been removed

from service earlier. The complete calibration test report by Siemens is contained in Appendix A of the Rizzo Report.

Figure 7-1 shows plots of ma output versus PSIG for TX2 and TX3 compared to a reference (ideal) transducer. Both TX2 and TX3 have linear response to pressure but TX2's ma output represents about a 7.86 feet higher indication than the reference curve while TX3's ma output represents about 0.85 feet higher indication than the reference curve. Figure 6 on page 20 of 76 in Appendix A of the Rizzo report shows that the as found PLC logic includes a subtraction of 9.38 feet from the TX2 pressure indication and a subtraction of 2.4 feet from the TX3 pressure indication. The basis for these adjustment values is not stated in Appendix A of the Rizzo report.

If the pressure transducers were located at the design elevation of 1500, these PLC subtractions in the pressure indications would be greater than they should have been based on the post-breach transducer calibrations and would have resulted in level readings about 1.5 feet lower than they should have been. However, if the pressure transducers were located above elevation 1500, the PLC subtraction values may have been selected to adjust the level readings to match the actual reservoir level. As such, the subtraction values would have adjusted the level readings for both the transducer offsets as well as actual elevation of the transducers.

Figure 7-2 shows plots of ma output versus temperature for TX2 and TX3 at a constant pressure of 40 PSIG (high upper reservoir level). While TX3 shows little response to temperature change, TX2 shows an unusual ma output shift between 5 degrees and 20 degrees. At temperatures below 5 degrees, TX2 indicates the pressure to be about 7.11 feet higher than that above 20 degrees for an actual constant pressure of 40 PSIG.

On December 13-14, 2005 the water temperature was in the 5 degree range. Since the upper reservoir level was calculated as the average of TX2 and TX3 on this date, the TX2 temperature shift output would have resulted in an indicated level of 3.56 feet higher than actual assuming that TX2 had been adjusted to match the actual level when the water temperature was above 20 degrees. By itself, the temperature response of TX2 as the water cooled would have indicated higher water levels and produced pump shutdowns at lower actual upper reservoir elevations for the same setpoint shutdown elevations.

Prior to removal of pressure transducer TX1 from service on September 27, 2005; the influence of temperature shift response in TX2 on the water level indication would have been less since it represented only one of three readings used in the average. After removal of TX1 from service, TX2 represented one of two readings used in the averaging process. Accordingly, the water level indication error due to water temperature changes would have been greater after September 27, 2005.

In response to FERC Question No. 29d., AmerenUE responded in part “It appears that TX2 did not exhibit the 0.5 ma shift until tested at the GE facility under extreme and abrupt temperature changes.” In any case, such a temperature shift response in cold water would have resulted in a higher water level indication rather than a lower indication.

A visual examination of the pressure transducer protective pipes, Figures 7-3 through 7-5, shows that the protective pipes had moved from their straight alignment in the lower elevation of the reservoir. Since the transducer cables remained fixed at their instrument box on the parapet wall (Figure 7-6), any movement of the protective pipes from their initial straight alignment would produce an upward movement of the pressure transducer and a corresponding negative error in the water level reading. That is, the reported water level would be less than the actual level.

To avoid penetrations of the liner material and the creation of possible leakage paths, the protective pipes were supported on plastic plates that were connected by eye bolts to two stainless steel guide cables. The cables were secured only at the bottom and top of the reservoir. Figures 7-7 and 7-8 show these support systems as found after the breach event.

An internal e-mail from September 27, 2005, written two days after Hurricane Rita, stated “This morning Jeff and I went up to the upper reservoir when the controls indicated we were at 1596 elev. There were no waves on the surface but we could see a couple of wet areas on the west side of the reservoir parapet walls. We pulled the vehicle up to these wet areas and climbed on top of the vehicle to see the water level. We were surprised to see the level within four inches of the top of the wall. It was above the top batten strip holding the vinyl on. This level is at least six inches higher than what I remember from when we first came back from the controls upgrade last fall. Jeff looked at the level xmtrs when we got back to the plant and found one of the three reading a foot higher than the other two. When he took that one xmtr out of the average we now read about 1596.2. I still feel we are about another .4 feet higher than that. Jeff then added a .4 adjustment to the two remaining xmtr average making the current level now read 1596.6. We’ll check on what this does to the actual level the next several mornings.”

Figures 7-9 through 7-11 show upper reservoir water level readings taken during and prior to the Hurricane Rita event.

Figure 7-12 (09/27/2005) shows the disabling of one upper reservoir pressure transducer and one lower reservoir pressure transducer and the addition of the 0.4 feet offset in the upper reservoir level indication.

Another internal e-mail also indicates that the protective pipe movement was observed as early as October 7, 2005 and that the pump shutdown set point was lowered from Elev. 1596 to Elev. 1594 “__so that we won’t pump over the reservoir walls.”

Figure 7-13 shows water level readings from December 2, 2005. Until the second pump turned on for the second time, the water level fluctuations are relatively small and may be due to surface wave action or small movement of the pressure transducers within the protective pipe. However, after restart of the second pump, these level reading fluctuations increased dramatically and no longer have a stable periodicity.

Figure 7-14 shows a continuation of water level readings from December 2, 2005. Once the level rose above about Elev. 1563, the large fluctuations decrease significantly and are very small when the water level was falling during generation later in the day. This pattern of water level fluctuations is found on most days after December 2, 2005. This evidence suggests that the pump discharge pattern created substantial forces acting on the protective pipes and/or the support cables when the water level is lower and that these forces diminish as the flow discharge pattern shifts upward at higher water levels. The evidence also suggests that the generation mode flow pattern into the intake is more stable and produces much less disturbance to the protective pipes. This is consistent with the much higher exit losses associated with discharge into an open reservoir compared to entrance losses for the same geometry.

The actual forces acting on the protective pipes and/or the support cables during pumping may have resulted from the flow around them. Flow over the protective pipes and cables may also have produced Von Karman vortex shedding. Such vortices would produce alternate forces toward the reservoir wall and away from the reservoir wall. Forces away from the reservoir wall would reduce the normal force between the pipe support plates and the reservoir liner. This reduced normal force might have allowed slipping of the support plate and pipes along the reservoir liner.

The graphs of upper reservoir water level for December 1st through December 13, 2005 show relatively stable indications during generation with one or both units, standstill and pumping with only one unit. However, once a second pump starts, the water level indications are generally more erratic. This tends to confirm that the higher flow from two pumps is providing the force moving the pressure transducers protective pipe.

A review of two pump operations during 2005 shows that the upper reservoir water level indications are reasonably stable until early August. Figures 7-15 through 7-22 are examples of these levels from the pressure transducers. Beginning in early August, the water level plots begin to show the erratic behavior that increased until December 14, 2005.

Figure 7-23 shows an interesting pattern of water level readings for December 10, 2005 with both units off followed by both units generating. We don't know if these level fluctuations are due to transducer movement or other causes. The left portion of the plot seems to be damping out until the disturbance around 14:24. The subsequent fluctuations appear to be building in amplitude until the two generators began operation.

Figure 7-24 shows the water level readings from the start of both pumps on December 13, 2005 through the reservoir failure on December 14, 2005. The – 222 MW arrow shows the indicated water level when pump 2 completed its start sequence. The water level indication remained level for about 12 minutes rather than immediately beginning the more rapid rate of rise that it should have. At that level of Elev. 1550, two pumps were producing a level rise of about 10 feet per hour or about 2 feet in those 12 minutes. While there were smaller subsequent level indication fluctuations, they did not restore the level readings back to the trend line shown.

The most logical explanation is that during those twelve minutes the transducers were moving up at about the same rate as the water level, hence showing no level change during the interval. The line labeled “Level trend without offset” shows where the water level indications should have been without the offset. It should be noted that the level indication at the beginning of the plot is not necessarily accurate given the many indications of prior transducer movement and erratic readings. It is also possible that generating mode flows past the transducers may have tended to bring the protective pipes back to near their original positions resulting in some periodic level error corrections.

Figure 7-25 shows indicated upper reservoir water levels around the time of the breach on December 14, 2005. A trend line has been added to show the calculated rate of rise for one pump operation at the maximum reservoir level. Note that the measured water level rate of rise matches the calculated trend line very closely to within a few minutes of the rapid drop in level. This suggests that the breach occurred very quickly after shut down of the second pump.

With a 15 minute per foot rate of rise for one pump and a minimum parapet elevation of 1597 at panel 72, more than 15 minutes would have been required to raise the water level from Elev. 1597 to Elev. 1598 since overtopping would have been occurring at panel 72 and other locations. Figure 7-25 does not show such a long period of reduced rate of rise prior to the breach. Therefore, the water level could not have reached as high as Elev. 1598.

Figure 7-26 is an enlargement of Figure 7-25 with two trend lines added. The left trend line represents rising water level prior to overtopping and the right trend line represents a reduced rate of level rise associated with beginning of overtopping. The lines intersect at about 5:07 AM suggesting that the actual level was around

Elev. 1597 at the time. An adjusted water level scale is included on the right of the plot based on an Elevation of 1597 at 5:07 AM. This analysis is based on level indications at the south end of the reservoir and does not include delay times associated with distance to the overtopping locations.

Figure 7-27 is a plot of maximum daily water level indications for December 2005. The plot shows that level indications as high as that shown for December 14, 2005 were achieved on many earlier days. Since reservoir failure did not occur on those dates, it suggests that the level reading offset described above for December 13, 2005 is primarily responsible for the failure to shut down the last pump. As noted above, that offset resulted in the actual water level being at least two feet higher than the pressure transducers indicated.

The buildup in level indication variations during pumping and the smoother level indications during generation suggest that the protective pipes were displaced due to pumping flows and tended to straighten out from generation flows and perhaps their own weight. We cannot be certain that the protective pipes always straightened out fully after a generation operation, so there may have been a residual level error when the pumps started on the evening of December 13, 2005 and at other times as well.

During our interview process, we asked operators from Osage and the St. Louis control center to describe the displays available to them showing upper reservoir water level. All interviewees stated that they have digital information as well as graphical displays of water level versus time. We then asked if they had ever seen any unusual indications on the graphical displays and all but one stated that they had not seen unusual indications. One interviewee did respond as follows; "I have seen a time or two where we've had a level problem, it would freeze up momentarily, and we've had them call and reset and it popped right back. I've seen that maybe once or twice."

We conclude that the failure of the second pump to shutdown automatically based on water level indication was due to level errors resulting from accumulated movement of the pressure transducers within their protective pipes including the twelve minutes of two units pumping on December 13, 2005 during which no level increase was indicated by the pressure transducers. Since the water temperature was in the 5 degree range on this evening, any influence of the TX2 temperature response would have been in the opposite direction to physical raising of the pressure transducers.

7.3 Emergency Water Level Protection Backup System as Found

An internal e-mail dated October 7, 2005 stated "The Hi and Hi-Hi Warrick probes are 7" and 4" from the top of the wall respectively. So if on 9-27 the level was 4" below the wall the Hi level Warrick should have picked up." And "If you want to lower the Hi level probes we can do that but I think we chose the levels

so that normal wave action wouldn't cause nuisance trips." Since the top of the wall at the location of the Warrick probes was determined to be at Elev. 1597.92 by AmerenUE in 2004 and 1598.0 by KdG after the breach in December 2005 the Hi-Hi probe could have ranged between Elev. 1597.59 and 1597.67; the Hi probes could have ranged from 1597.35 to 1597.42.

After the breach, the Hi and Hi-Hi conductivity probes were found to be 4" and 7" below the top of the wall as described in the above e-mail of October 7, 2005. As shown on Figure 7-28, this places the Hi-Hi probe above the top of Panel 95 (1597.39), in the breached area and above the top of Panel 72 (1596.99), the minimum elevation of any panel in the reservoir. We received no documents or interview responses indicating why or when the conductivity probes were raised to these elevations.

Since the conductivity probe system had operated correctly when tested at commissioning in the fall of 2004, we investigated the following possible reasons for failure to respond before the breach.

Estimates of the maximum reservoir water level achieved prior to the breach were made by several parties using the following methods:

- Elev. 1597.63 based on examination of dike crest for evidence of water spill (erosion).
- Elev. 1596.74 based on post breach observed vertical movement of transducer pipes.
- Elev. 1597.4 based on examination of pressure transducer data for reduction in rate of rise while pumping suggesting Elevation 1597 (panel 72).

Figure 7-29 shows areas of erosion around the upper reservoir perimeter. Estimates of the maximum reservoir water level were made by noting the parapet levels adjacent to these erosion areas.

AmerenUE measured a 14 foot lateral displacement of the transducer pipes over an arc length of 119 feet in the displaced pipe as found after the breach event. This results in a calculated vertical movement of about 3 feet for the enclosed transducers. Adding 3 feet to the maximum measured water level of 1593.74 gives an adjusted water level of 1596.74.

It should be noted that the as found displaced position of the transducer pipes does not necessarily represent the maximum position achieved prior to the breach event. In the days following the event, the transducer pipes gradually straightened out and moved back to near their original position. As such, the actual vertical movement of the pressure transducers was likely somewhat higher than the calculated 3 feet value.

Figure 7-30 shows a maximum water level of about Elev. 1597.4 based on indexing the pressure transducer record to Elev. 1597 when the rate of rise decreased during one pump operation.

Figure 7-28 is a summary of the results including the as found elevations of the Hi and Hi-Hi conductivity probes. The estimated level during breach is shown as a range of levels dependent on method of calculation noted above. The maximum water level based on the as found displaced shape of the transducer pipes is excluded for the reason given above.

While some estimates of maximum water level are higher than the Hi probe elevation, none of the selected estimates reach the Hi-Hi probe elevation. These results are consistent with the fact that no probe alarms were recorded on December 14, 2005 since an alarm is only initiated from the Hi-Hi probe and not from the Hi probe.

While we consider the above to be the most likely explanation for failure of the conductivity probe system to initiate pump shutdown, we considered the following additional possibilities.

At our request, a series of tests was conducted to investigate the sensitivity of the probe system to the following conditions:

- Clear vs. turbid water.
- Water temperature variation.
- Relay supply voltage variation.
- Ice on probes.

The results demonstrated that the conductivity probes and relays performed satisfactorily for all test conditions.

However, the investigation documented a programming error in the Unit #2 pump shutdown logic. This PLC error, made on September 16, 2005, disabled the Unit #2 shutdown in response to operation of any conductivity probe (Lo, Lo-Lo, Hi, Hi-Hi). The Unit #1 shutdown logic did not include this error. Figure 7-31 shows the final as found shutdown logic.

Since Unit #2 was shutdown manually on December 14, 2005, the programming error was not a factor in the overtopping event. Based on the above test results, Unit #1 would have shutdown automatically if the Hi and Hi-Hi probes had remained wet for the required sixty seconds.

We conclude that the Hi and Hi-Hi conductivity probes were located too high to initiate pump shutdown and prevent overtopping of the upper reservoir. As noted above, the programming error in the Unit #2 shutdown logic was not a factor in the December 14, 2005 breach of the upper reservoir.

7.4 Overtopping of Embankment Dam

7.4.1 Sensitivity of Taum Sauk Dumped Rockfill Dam to Overtopping

It is well known in the Dam Engineering profession that overtopping of embankment dams is one of the most frequent causes of embankment dam failures. In 1972 Buffalo Creek Dam in West Virginia failed by overtopping and 118 persons were killed. The dam was built from mine wastes. In 1977 two earth dams on the same river in Brazil were overtopped and failed during a storm. In 1964 flow through a 200 ft high section of Hell Hole Dam in California, under construction, resulted in a failure and the dam had to be rebuilt. The downstream slope of the dumped rockfill was a 1.3:1 slope which had a dominant size (diameter for 50% passing), Leps 1973, of about 8-12 inches. In any case, the Hell Hole failure is an incident where the exiting of seepage on a 1.3:1 dumped rockfill slope resulted in erosion and instability of the slope.

Because all embankment dams are considered to be vulnerable to failure by overtopping, embankment dams usually have spillways and failures still result in some cases due to either inadequate spillway capacity or improper operation of spillway gates, caused by human error.

In the case of pumped storage projects, the Upper Reservoir in many cases is not connected to a river and the reservoir levels are determined solely by the controlled pumping and generating activities. A study of precedent indicates that based on the philosophy of the various owners and engineers that some of these projects have a spillway capacity equal to the pumping capacity and others have no spillway at all and rely on controlling the reservoir level and terminating the pumping at predetermined reservoir levels. The Taum Sauk Project was constructed without a spillway and thus was dependent on monitoring to control reservoir levels to prevent overtopping. It is interesting that in the middle 1960's that Taum Sauk and Cabin Creek were the only two pumped storage projects without spillways on the Upper Reservoir to pass errant pump overflows.

Although it should be assumed in design that all embankment dams will fail if overtopped, some rockfill dams are more sensitive to failure by overtopping than others depending on the steepness of the downstream slope, the compactness of the rockfill, and the percentages of sand and fines in the rockfill.

Based on the appearance of the breach slopes at the Taum Sauk rockfill embankment during the initial inspection of December 15, 2005, it was evident that the embankment in the area of the breach was not constructed as a normal rockfill embankment. At best it should be classified as a "dirty rockfill" in the breach area as is shown in Figure 6-4. The recent drilling and investigation program conducted by Paul C. Rizzo Associates (PCR) has also indicated that

the Upper Reservoir Embankment materials contain much finer materials than expected for a rockfill embankment. The recent program conducted in January 2006 involved drilling (7) borings using a 6 inch sampler and sonic drilling techniques. Even after correcting and adjusting for the smaller samples, the inferred rockfill gradations indicated fines contents as high as 20% passing the # 200 sieve. Reference PCR Forensic Report Dated April 6, 2006.

Studies of the rockfill gradations at Taum Sauk by PCR have resulted in the Lower and Upper bound grain size distribution curves, as shown in Figure 7-5 of the PCR Report and given in Figure 7-32 in this report. It is shown in Figure 7-32 that for the upper bound sizes of rockfill at Taum Sauk that the dominant size (50% passing) is 4 inches and that for the lower bound sizes that the dominant size is about 3/8 inch. Thus the dominant size of rock fill at Taum Sauk is significantly smaller than the Hell Hole dominant size range of 8-12 inches, as discussed above; thus the rockfill at Taum Sauk would be considered to be more vulnerable to erosion than the Hell Hole rockfill. Panel Member Hendron had the opportunity to inspect the rockfill at the rebuilt Hell Hole Dam in 1966 and can attest that the gabbro rockfill at Hell Hole Dam was much stronger and of larger size than the Taum Sauk rockfill. The Hell Hole rock appeared not to have any materials passing the No. 200 sieve, whereas the range of curves shown in Figure 7-32 indicate that there was from 0-20% passing the No. 200 sieve and from 0 to 45% sand in the rockfill at Taum Sauk. Due to the steep downstream slope and the small dominant size range of the dumped rockfill at Taum Sauk it is the Panel's judgment that the Upper Reservoir embankment dam slopes in the area of the breach were composed of "dirty" rockfill and were very erodible as compared to other rockfill dams, especially other compacted rockfill dams. In fact the historical documentation of the project contains many comments by James Barry Cooke and others about the erosion of portions of the slopes due to rainfall.

It is noteworthy that Cabin Creek Dam was constructed as an upper reservoir dam for a pumped storage project in Colorado. This dam was completed about a year after Taum Sauk and consisted of granite rockfill compacted in two ft thick lifts with a maximum size of 2 ft. The rockfill did not have measurable amounts passing the #200 sieve and had a maximum percentage passing the 1-inch size of 10%. The downstream rockfill slope was 1.75:1. This dam was overtopped by over pumping but did not fail. It is no doubt in large part due to the fact that the dam was well compacted clean rockfill, as opposed to being dumped, and the downstream rockfill slope was somewhat flatter at 1.75:1 as compared to the dumped "dirty" rockfill slope of 1.3:1 at Taum Sauk.

The "dirty" rockfill found at Taum Sauk, with as much as 45% sand plus fines, was likely not free draining for the flows imposed by overtopping. Thus, the flows from overtopping could increase the phreatic levels beneath the parapet wall and within the downstream slope. In the case of a steep downstream slope of 1.3:1, the phreatic levels do not need to be increased very much to cause instability of

many potential failure surfaces. The designs of steep sloped CFRD's are predicated on the assumption that the rockfill is free draining. The rockfill found at the Taum Sauk Breach may in fact not be free draining, and increases in piezometric levels caused by the overtopping flows could also have initiated stability failures of various portions of the slope and/or sliding and overturning of the parapet wall, as well as erosion.

The failure of the Gouhou Concrete Face Sand and Gravel Dam in China, on August 27, 1993, is pertinent to the Taum Sauk breach. Gouhou Dam had an upstream slope of 1.6:1 and a downstream slope of 1.5:1 and was a well compacted gravel which contained, on the average, about 40% sand. The top of the face slab was at Elev. 3277.35 meters where there was a joint between the horizontal footing of a parapet wall and the top of the face slab. The dam had been in service for more than 3 years but the reservoir level had never exceeded Elev. 3277.35 meters. An investigation of the failure found that the dam failed within about 24 hours after the water elevation exceeded 3277.35 meters. It was concluded from this study, in a paper by Zuyu Chen, October 1993, that the infiltration into the gravel-sand fill, from the face slab-parapet wall joint, increased the phreatic surfaces in the dam due to the fact that the gravel-sand fill was not free-draining and resulted in failure of the downstream slope. This particular failure is pertinent to the Taum Sauk case because it is an illustration of the mode of failure which can and did happen in the case due to leakage through a concrete face and of parapet wall-face joint into a less than free-draining embankment fill. This is one of the hazards of permitting a "dirty" rockfill; the Taum Sauk fill could have had as much as 45% sand sizes or smaller which of course was similar to the percentage of sand in the Gouhou embankment fill.

7.4.2 Effect of Storing Water on Parapet Wall

The effects of storing water against a parapet wall as a "normal" routine loading when the embankment is a dumped rockfill dam are to increase the number of potential modes of failure and to intensify or increase the probability of occurrence of other modes of failure which existed prior to the decision to store water against a parapet wall founded on the dam crest.

For example, the placement of a 10 ft-high parapet wall on the crest of a dumped rockfill dam before settlements are complete most likely will result in differential settlements along the wall; and, the downstream movements associated with the water loading on the dam face and upstream side of the wall will result in opening of the joints between the parapet wall panels. This opening of the parapet wall joints results in additional leakage through the wall joints which would not occur if the parapet wall were not used to contain operating reservoir levels. This leakage could decrease the stability of the slope upon penetration into a dirty rockfill or it could be the cause of surface erosion of the downstream slope surface.

In the case of overtopping of a 10-ft high parapet wall, the velocity of the water impinges on the dam crest with a velocity of about 25 ft/sec., which is enough to accelerate erosion at the toe of the wall and results in the water having an initial velocity down the downstream slope, which enhances the erosion capability of a given flow over the top of the wall.

In the most severe case, the overtopping water may erode the rockfill at the toe of the wall footing enough that the 60 ft wide parapet wall panel tips over and results in an immediate flow through the 60 ft wide opening of about 7,000 ft³/sec. This large discharge is an immediately available source of erosive energy at the top of the slope; it is a source of erosive energy which would not be available if the wall were not used as a storage mechanism.

For the Taum Sauk Upper Reservoir, the probability of overtopping the parapet wall was high in the case of any instrument errors because the shut off elevation of 1596 was too close to the low point on the top of the wall of 1596.99 at Panel 72.

7.4.3 Foundation of Rockfill Dam

The foundation rock at the Upper Reservoir Dike, being the flattened top of Proffit Mountain, is generally fresh to slightly weathered, hard, moderately to abundantly jointed rhyolite. Joints are generally steeply dipping, open, and some were filled with clayey products of weathering such that seepage would occur without proper measures to seal the reservoir floor. During construction, the overburden was observed to vary from a few feet to as much as 65 feet thick (MWH, 2003). Several significant clay seams, gently dipping, and up to four inches in thickness were encountered. Under the dike, the seams were treated either by excavating and backfilling with concrete or covering with smaller-sized compacted rockfill. The upstream (or inside) 70 feet of the base of the dike was specified to be prepared such that not more than two-inches (average) of soil were left in place. A filter zone and several layers of compacted rock were placed over questionable areas where piping of the foundation might be possible. Outside the 70-foot zone, the weathered rock was left in place where its competence was judged equivalent to the rockfill. Low areas or depressions in the natural topography were filled with compacted rock. Drainage to the outer slopes was reportedly provided for all foundation areas.

During IPOC inspections at the site, a residual soil zone of weathered rhyolite could also be observed in the breach area; and one location is shown in Figure 6-4. The residual soil was observed to be clayey and it was judged to have an effective shear strength almost dictated by the clay portion of the soil. Exposed rhyolite bedrock is also observed in Figure 6-4 as well as the remnants of the lower face slab and plinth.

A closer view of the exposed rhyolite bedrock and residual soil is shown in Figure 6-5. This photo is taken looking east and the rather flat looking joint surface in the rhyolite dips toward the camera in a westerly direction. This discontinuity was observed in the field to dip nearly west at a dip of about 10° . This discontinuity is described as Fracture Set 8 (FS-8) in the Rizzo Report and is reported to have a dip of 8° and a dip azimuth of 270° . As a result of the observation of the residual soil, the IPOC requested that samples of the residual soil be taken for direct shear testing.

The shear strengths reported in the Rizzo Forensic Report ranged from an “effective” angle of shearing resistance of 28° to 38° , with a best fit of 33° , when the data is interpreted with a cohesion value of 0. It is possible that this zone of residual soil of weathered rhyolite was present downstream of the 70 ft. wide stripped area and could control the overall stability of the embankment, rather than the angle of shearing resistance of the rockfill, as the angle of shearing resistance is less than the rockfill and the zone of residual soil dips down the hill parallel to the original topography. The low dipping joint surface shown in Figure 6-5 is important in that it serves to give a foundation discontinuity which daylight to the west side of the embankment and gives a foundation that in general dips downhill at about $8-10^{\circ}$ in the direction of the applied water forces. In addition some of these joint surfaces appear to have clay coatings.

Considering the downstream sloping topography of the embankment foundation of residual soil overburden and the significant clay coated joints within the foundation rock that also gently dip to the west, together with the steep embankment slopes, it is understandable that the stability of the embankment may have been marginally stable and vulnerable with the additional conditions imposed by overtopping. The surcharge conditions imposed by the water flowing over the parapet wall and over or through the embankment materials may have induced higher phreatic surfaces and caused sliding along the base as well as facilitated shallow slope movements during the progressive failure of the Upper Reservoir embankment.

7.5 Possible Failure Modes

7.5.1 General

The experience that the embankment and parapet wall survived maximum water levels between Elev. 1595 and 1596 many times between 1963 and 2004 with leakage out of the reservoir ranging from 10 to 100 cfs indicates that the dam was stable for the conditions present before the liner was installed in 2004. This observation indicates only that the Factors of Safety of the dam slopes, and the Factors of Safety of the wall against overturning and sliding were greater than 1.0 for various potential sliding surfaces for conditions prior to 2004. This does not mean that the actual Factors of Safety between 1963 and 2004 would meet 2006 standards or FERC Guidelines, but that is really only an academic discussion

anyway because in this report we are mainly concerned with the technical reasons for breach on December 14, 2005.

After the fall of 2004, the geomembrane covered the face slab and reservoir face of the parapet wall which reduced the total leakage from the Upper Reservoir to about 5-10 cfs. Thus the possible local phreatic surfaces around the wall and its footing as well as phreatic surfaces within the dam should have been lower than they have ever been and the Factor of Safety of all modes of failure should have been higher than at any time in the history of the project for the 1596 reservoir levels without the effects of wall overtopping. The chronology of events strongly suggest that although the construction of the liner made the Upper Reservoir dam more stable, that the unreliable instrumentation system and the missetting of the Warrick Probes made overtopping possible. Moreover field observations after the breach indicated that overtopping did occur. Thus the modes of failure discussed below are only those associated with overtopping. The dam is assumed to have proved its stability before the overtopping event of December 14, 2005.

7.5.2 Discussion of Specific Modes of Failure

Mode a) The 1.3:1 slopes (37.5°) are very steep and when overtopping occurs it is very easy to get erosion down the slope surface and a local increase in phreatic surface parallel to the slope which can result in shallow progressive sloughing of the slope possibly from the toe upward until the sloughing begins to undermine the parapet wall which leads to sliding and overturning of the wall which then greatly increases the flow as one 60 ft. wide panel overturns or slides resulting in a very high flow which greatly accelerates the failure by immediately imposing a flow of 7,000 cfs on the slope.

Mode b) As overtopping initiates the process in a) above and the progressive sloughing takes place, the flow of water over the top of the 10 ft. high wall impinges at the dam crest at a velocity of 25 ft./sec. and begins locally undermining the wall footing in addition to the sloughing caused by thin layers becoming saturated and failing deeper with time. This shortens the time required to reach overturning or sliding of the wall. In addition to undermining the wall footing, this jet of water at 25 ft./sec. impinges on the upper finer rockfill and can locally transfer to a 10 ft. pressure head which can change the stability of the wall by changing the uplift pressures at the wall toe.

Mode c) It is possible that the local increase in the phreatic surface between the parapet wall and the upper part of the slope caused by the impinging jet of water can cause a local wedge just beneath the wall to deform and/or reach limiting equilibrium without the entire slope below becoming unstable. This is similar to the case considered by means of a FLAC analysis in the FERC Breach Report as shown in FERC Report Figure 9.5. This is one possible mechanism which is

enhanced by the high parapet wall loading in excess of 10 ft. of water head. It is obvious that this mechanism can occur combined with a) and b) above.

Mode d) Another mode of failure can be deep wedges founded on a base of residual soil inclined downhill at about 10°. The various wedges could have steep backslopes as shown in Figures 8-22, 8-26, and 8-28 of the Rizzo Report and can be analyzed for varying phreatic levels on the residual soil base.

7.5.3 Comments

According to the stability analyses conducted by PCR and FERC potential failure mode a) is very likely and the progressive sloughing and erosion in a) can be accelerated, leading to sliding or overturning of the wall, when taking into account the local undermining of the wall by the velocity of the water jet impinging on the downstream side of the parapet wall footing as described in b) above. According to the PCR calculations the parapet wall is likely to fail by overturning if undermined by 3 ft. Mechanism c) described above seems possible and was indicated by a FLAC analysis conducted by FERC. The deep wedges of mode of failure d) were analyzed by PCR and required the phreatic surface near the toe to build up to about 30 ft. above the base of the toe of the dam. This mechanism is possible but the time for this deep phreatic surface to build up 30 ft. is somewhat problematic considering that the “dirty” rockfill will result in a high percentage of water runoff rather than deep infiltration.

It is the judgment of the IPOC that we most likely will not ever know the exact sequence of failure at the breach. It seems most likely that the failure mode was a combination of modes a), b) and c) described above. The participation of a deeper mode such a d) cannot be excluded however especially after any wall panel overturning results in a huge flow of water.

8. Conclusions

The Upper Reservoir Embankment has had a long history of settlement and high leakage increasing to about 60-100 cfs between 1999 and 2003. Although there were many periods of concern and repair was required to keep the water within the reservoir, the embankment and parapet wall did function for 42 years as the containment structure for the Upper Reservoir. The steep rockfill embankment, as discussed in Section 3.1, was possibly marginally stable for the actual “dirty” dumped rockfill and the seepage conditions previously experienced. After installing the geomembrane liner in 2004, it is most likely that the Upper Reservoir Dam was more stable than it has ever been under normal loading because the total leakage was only 5-10 cfs. Nevertheless there was no margin for accepting the additional pore pressures and erosive effects of overtopping, as was the case with the failure on December 14, 2005.

It is the Panel's opinion that the cause of the December 14, 2005 failure was overtopping of the parapet wall and embankment. The possible modes of failure for the breach event of this dam and the factors which made this dam especially vulnerable and sensitive to overtopping have been discussed in Section 7.

Although this dam and parapet wall combined to give an embankment more vulnerable and sensitive to overtopping than most embankment dams it is the opinion of this Panel that the primary root causes of failure on this particular date were those factors which caused the overtopping to occur. The secondary root causes or contributing factors are those factors which combined to make this embankment more vulnerable to failure by overtopping.

A summary of primary root causes is given below. These factors contributed to the fact that overtopping occurred.

- The pressure transducers that monitored reservoir water levels became unattached from their supports causing erroneous water level readings.
After these transducers became loose from their supports, their position heads changed and the reservoir levels indicated in the PLC system gave reservoir levels lower than the actual reservoir levels. The fact that the new system installed in 2004 did not consist of a structural support system anchored to the face slab enabled this mode of instrument failure to occur. As constructed it was inferior to all of the water level measuring systems used on the Project between 1963 and 2004.
- The emergency backup level probes were set at an elevation above the lowest points along the parapet wall; thus, they failed their protection role because this enabled overtopping to occur before the probes could trigger shutdown.
These probes were a good conceptual second line of defense. However, the Hi-Hi Warrick Probe had to be in contact with the reservoir water for 60 seconds in order to trip off the last pumping unit. The Hi-Hi Warrick Probe unfortunately was set at Elev. 1597.7 at Panel 58 where the top of the parapet wall was at 1598.0 It did not apparently occur to those setting this probe that there were 33 wall panels with their tops lower than the Hi-Hi probe with the lowest one (Panel 72) having a top at Elev. 1597.0 Thus the emergency backup system was effectively eliminated by this error of setting the Warrick Probe at an elevation which would allow considerable overtopping, if the main system would fail.
- The normal operating high water levels of 1 ft. below the top of the parapet wall was too near the top of the wall to allow for any mistakes of mis-operation.

This low free board was not realistic for the system adopted for monitoring water levels in 2004. A more rigorous study of the potential errors in the measurements should have been made before adopting this low free board which required such a high accuracy from this system. The adoption of this 1 ft. free board was totally inconsistent with having personnel making key design and installation decisions who were not even aware of the lowest elevation of the parapet wall within the nearest 1 ft.

- Visual monitoring of the Upper Reservoir water levels was almost non-existent and there was no systematic “ground–proofing” recorded of the relationship of the top of the wall and associated water levels actually being achieved.
- There was no overflow spillway to safely carry accidental over-pumped water downstream and below the dam.

The omission of a spillway from the design was a most important root cause of this failure. If a spillway had been constructed with a capacity of the two pumping units, an overtopping failure would not have occurred.

A bullet point for a secondary root cause of the December 14, 2005 breach is given below with detailed explanation.

- The marginally stable dumped “dirty” rockfill embankment and associated parapet wall atop the dam, constituted an unforgiving containment structure. It could not tolerate the additional pore pressures and erosive effects of the overtopping water plunging over the top of the parapet wall onto the narrow dam crest and cascading down the steep 1.3:1 slope.

The steep dumped rockfill slopes composed of rockfill with as much as 20% fines and 45% sand sizes and smaller, make this dam especially sensitive to erosion due to overtopping and also conducive to increases in pore pressures during overtopping because it is not free draining. Storing water against a 10 ft. high parapet wall founded on the dam crest is also a feature which makes this dam vulnerable to overtopping because the overflowing water impinges on the dam crest at a velocity of 25 ft./sec. which enhances erosion and makes a large release of erosive energy possible, should the erosion at the downstream footing of the wall allow tipping or sliding of the wall. As indicated in previous sections of this report there were plenty of indications, earlier in the history of this dam, that there was “dirty” rockfill in portions of this dam and much of the repairs as well as comments in writing were directed to the area of the dam that breached between Panels 88 and 99.

Appendix A

IPOC Information Request Letter

Alfred J. Hendron, Jr.
No. 4 College Park Court
Savoy, IL 61874

Joseph L. Ehasz
11485 Upper Meadow Drive
Gold River, CA 95670

Kermit Paul
15 Boies Ct.
Pleasant Hill, CA 94523

6 January 2006

Mr. Constantine Tjoumas
Director, Division of Dam Safety and Inspections
Federal Energy Regulatory Commission
888 First Street, NE, Room 6N-01
Washington, D.C. 20426

Re: Initial Information Request
FERC Independent Panel of Consultants (IPOC)
Taum Sauk Pumped Storage Project

Dear Mr. Tjoumas:

At your request we have agreed to serve as an Independent Panel of Consultants (IPOC) to investigate the breach of the Upper Reservoir of the Taum Sauk Pumped Storage Project that occurred the morning of December 14, 2005. Each panel member has visited the site, Hendron on 15 December, 2005, Ehasz and Paul on 29 December 2005. Members Ehasz and Paul visited the Osage and Saint Louis Ameren operation centers 30 December 2005. These visits were instructive and required to start our investigation. To further the Panel's investigation, the Panel has assembled the initial information request list, enclosed. If you have any questions regarding any of the requested items or tasks please call any of the Panel members.

Respectfully Submitted,

Alfred J. Hendron, Jr.

Joseph L. Ehasz

Kermit Paul

Taum Sauk Pumped Storage Project
Initial Information Request of IPOC
January 3, 2006

1. As-built drawings of Upper Reservoir, cross sections, verification tests, etc
Also provide a detailed topo map of the upper reservoir site prior to construction.
2. Any board of consultant reports during design and construction and thereafter.
3. Any design memos, design criteria, design drawings or field reports during construction
4. Any construction photos or construction videos
5. Embankment instrumentation plots, settlement readings, movement readings, weir readings (also provide weir designation, location and zone of embankment measured by each weir). History of leakage as related to face slab/parapet wall movements between January 1999 and January 2000.
6. FERC annual reports, part 12 inspection reports, and Utility/Owner inspection reports/sheets filled out between FERC annual and part 12 inspections.
7. Parapet wall design and calculations
8. Parapet wall and embankment crest elevations and movements along entire perimeter.
 - a. Top elevation at both ends of each parapet panel
 - b. x-y movements of parapet walls (horizontal movements if known)
 - c. Elevation and x-y movements of top of embankment.
 - d. Openings measured at parapet wall joints, also document direction of relative movement between panels.

**Taum Sauk Pumped Storage Project
Initial Information Request of IPOC
January 3, 2006**

9. Operation criteria with respect to reservoir water levels, i.e. summer (1596) verses winter (1589). Original design water levels and most recent target levels. What was the previous method for controlling water levels?
10. Locations and elevation of piezometer water level indicators and settings
11. Locations and settings for high and high-high water trip devices
12. Describe types of QC checks of water level instrumentation that were conducted, both physical and electrical
13. Computer plots with data tables of upper reservoir water levels for the seven days prior to December 14, 2005 as well as the day of December 14, 2005. Also request this data and plots for as far back as possible.
14. Since November 2004, how often were the upper reservoir piezometer and high level trip devices tested. How often were they adjusted with respect to placement within the PVC pipes?
15. Document grain size distribution of embankment rock fill.
16. Document foundation materials of the embankment, define/characterize the clayey type material zone and weathered bedrock zone.
17. Location, purpose and logs of any boring done on the upper reservoir site since initial construction was completed.

**Taum Sauk Pumped Storage Project
Initial Information Request of IPOC
January 3, 2006**

18. Chronology of all maintenance/repairs and changes to upper reservoir, including but not limited to parapet wall, face slab, crest road, access road, embankment instrumentation, reservoir instrumentation, etc.

19. Design and construction reports from Geo-Synthetics, Inc. related to membrane liner assessment and placement. Any documents/photos related to assessment or surveys (crack mapping, identification/characterization of offsets, etc.) of the concrete face slab and parapet walls or their joints prior to placement of the membrane liner. Any documents/photos related to details on how concrete face slab and parapet walls or their joints were prepared/treated prior to membrane liner placement.

20. Document locations/extent the parapet wall was over topped.

21. Flow chart of personnel that interact with the project.

- a. Name
- b. Title, physical location of work office or area.
- c. Job/task description, decisions made during work period. What do you control and observe? Who do you report to?
- d. List other personnel that you communicate with? What information is shared during the communication? Purpose of the information? How often is this done during a work period?

22. Who has walked along/inspected the dam crest when the reservoir was full? How often was this done? What has been observed? If possible we would like to review what ever was written about each inspection. Who receives this information? How is the information assessed?

**Taum Sauk Pumped Storage Project
Initial Information Request of IPOC
January 3, 2006**

23. If the Panel members feel certain information is lacking with respect to characterization of foundation conditions or concrete face slab joints or parapet wall joints, the panel may request, excavation of trenches, exploratory borings or to view concrete face slab or parapet wall joints at certain locations.

24. Names and locations of Utility personnel associated with the Taum Sauk Project on duty at the time of the 14 December Dam breach.

25. Will a High Definition 3D Laser Scanning Survey for the breach area and slope failure area near panels 71-72 be done? If so, consider some of the other areas that experienced severe embankment deformation/crest erosion as well.

26. Area/Capacity curve for the upper and lower reservoirs.

27. Any videos taken at any time showing pump discharge into reservoir especially near location of pressure transducers and conductivity probes and at various water elevations.

28. Power Plant;

- a. Pump/turbine head vs. capacity curve
- b. Elementary diagram(s) for generator/motor showing master relays and protective circuits including interface with high water level conductivity probes in upper reservoir.
- c. Alarm logs of December 14, 2005
- d. General arrangement drawings (plan and section).
- e. Description of normal pump shutdown sequence and emergency pump shutdown sequence with associated timings.

**Taum Sauk Pumped Storage Project
Initial Information Request of IPOC
January 3, 2006**

29. Water Level Monitoring and Protective Systems;
- a. Specifications, drawings, catalog outs of components, photos, test and inspection records, operating manuals, calibration records. Include Programmable Logic Controllers and communication systems.
 - b. Design Criteria and any documentation related to discussions of logic used in conductivity probe system. For example, how/why was decision made to require both probes to remain "wet" for 60 seconds before tripping unit?
 - c. Data, photos, and description of older "skate" and float systems.
 - d. Results of post event calibrations of pressure transducers.
 - e. Date that "suspect" pressure transducer was removed from "averaging" use and any checks/tests made to determine problem with transducer.
 - f. Fault tree analysis of entire system from transducers to relay used in generator/motor shutdown circuit.
 - g. Description of intrusion/tampering detection system (if any) at upper reservoir equipment enclosure. Log of alarms from such a system.
 - h. What was elevation of conductivity probes when found after December 14, 2005 event.
 - i. Licensee's procedures for periodic testing/calibration of pressure transducer and conductivity probe system including logs of such results.

**Taum Sauk Pumped Storage Project
Initial Information Request of IPOC
January 3, 2006**

30. Tasks for FERC Support Group;

- a. Prepare summary by date and time of all alarms and pumping shutdowns (if any) initiated by Hi and Hi-Hi conductivity probes and corresponding readings of upper reservoir water level from pressure transducers.
- b. Summarize weather conditions for December 14, 2005 (close as possible to site) and determine if worse conditions existed on other dates after pressure transducer and conductivity probes were installed.
- c. Request licensee to conduct tests on conductivity probe system to determine sensitivity to water conditions (clear vs. turbid), water temperature, supply voltage, ice, etc. FERC staff to witness test.
- d. Request licensee to conduct test to verify that placing both conductivity probes in pail of water for 60 seconds at upper reservoir will result in operation (drop-out or pick-up) of appropriate relay at power plant. Also test to verify that operation of that relay results in drop-out of the pump mode master relay (4P?). Conduct test by placing a variable resistance (decade box) across the two sensing elements on the conductivity probe(s) in air and determine the maximum resistance in ohms that will consistently actuate the output device. FERC staff to witness tests.
- e. Request licensee to conduct investigation into cause for movement of protective plastic pipes around the pressure transducer probes. If pipe clamp anchor bolts failed, did they shear off, fatigue or other? Is there evidence of tampering?
- f. Provide any information about over-pumping protection systems used by other pumped storage owners.

**Taum Sauk Pumped Storage Project
Initial Information Request of IPOC
January 3, 2006**

- g. Review digital records of upper reservoir water level for evidence of vertical upward movement of pressure transducers. Was movement gradual, sudden, or a series of steps? If movements can be identified, what was status of pump/turbines (generating, pumping or shut-down)? Also review these records to identify change in water level readings resulting from licensee re-adjusting readings to match staff gauge in reservoir.
- h. When was licensee first aware of movements of protective pipes and what was their response?
- i. Calculate and plot upper reservoir rate of rise (in./min.) versus elevation using area/capacity curve and pump/turbine head vs. capacity curve.
- j. If we want to develop a possible reason for movement of the protective pipes around the transducers, we may need to have someone such as Voith-Siemens or American-Hydro do a CFD model of the velocity distribution around the intake/discharge opening at the upper reservoir for various water levels. The objective would be to evaluate the velocity magnitudes and directions next to the protective pipes. The location of the pipe movement at the lower rather than upper elevation in the reservoir and the direction of movement away from the intake/discharge opening appear consistent with the forces from the pump discharge. FERC should advise if a CFD model should be done. This may not be necessary if licensee can produce videos requested above.
- k. Purchase or borrow a conductivity probe with associated electronics box (relay). Place probe above a cold body of water to see if we can form an ice skin on the probes without triggering the electronics box. Then plunge the probe into a pail of water to see if the ice skin prevents the probe from triggering the electronics. The electronics may have a sensitivity adjustment so we need to set it at the same value that licensee had on their devices. This test will determine if the conductivity probe system can be defeated by cold weather conditions.

Appendix B
Event Chronology

FERC SECTION 6 EVENT CHRONLOGY

6.1 January 2002 –December 2005

Taum Sauk Upper Reservoir Breach Time Line

Date	Event
January 3, 2002	<ul style="list-style-type: none"> • Ameren sends plans and specs and design calculations for installation of a geomembrane liner to D2SI-CRO for review. • In letter, Ameren proposes starting construction on March 25, 2002.
March 1, 2002	<ul style="list-style-type: none"> • D2SI-CRO sends letter stating it has no comments on the plans and specs. The letter asks for an erosion control plan and states inspections will be performed in conjunction with the Operation Inspection and a final inspection near the end of construction.
April 22, 2002	<ul style="list-style-type: none"> • Ameren informs D2SI-CRO by phone that budget of the liner has been exceeded and work has not been completed within schedule. Ameren states the geomembrane installation will take place in Fall 2003. • Work completed to date includes installation of the toe sill and snap-lock around the interior perimeter, patching of critical areas with gunite, and pouring concrete in an area that has the most severe leakage.
November 5, 2002	<ul style="list-style-type: none"> • Ameren sends letter to D2SI-CRO stating between September 26 and October 18 of that year, the upper reservoir and penstocks were drained to do maintenance work on the units. During this time an inspection of the liner revealed cracks in the floor of the tunnel liner about 1500 feet up from the plant. Repairs were made at that time. (What type of repairs?)
March 6, 2003	<ul style="list-style-type: none"> • Ameren sends letter to D2SI-CRO stating liner project is being postponed to start in September 2004 and be completed by the end of the year.
April 24, 2003	<ul style="list-style-type: none"> • D2SI-CRO sends letter to Ameren regarding postponement of liner installation. The letter notes leakage is steadily increasing from an average of 30

	<p>cfs during 2000 to about 65 cfs during the first quarter of 2003. Some of the leakage has been attributed to leaky seals in the units. The revised schedule is accepted because Ameren is continually monitoring leakage and making underwater repairs to the concrete liner in the interim. Also, it is noted the pumped storage facility is frequently drained and can be drained should the leakage become excessive.</p>
March 15, 2004	<ul style="list-style-type: none"> • D2SI-CRO sends letter to Ameren requiring a Quality Control and Inspection Program be submitted at least 60 days before doing liner work schedule for September 2004.
July 23, 2004	<ul style="list-style-type: none"> • Ameren submits QCIP for liner installation to D2SI-CRO. Notes contractor proposes to start work on September 13, 2004.
September 9, 2004	<ul style="list-style-type: none"> • D2SI-CRO sends letter to Ameren regarding liner installation. • States D2SI-CRO reviewed again the plans and specifications submitted in 2002 and QCIP and have no comments. • States the work is considered maintenance. • Requires monthly construction reports and certifications from the design engineer, QCIP manager, and licensee that project is constructed in accordance with design intent and plans and specs. • Notes if plans and specs are revised, the licensee must assure that changes are coordinated between the engineer, QCIP manager, FERC, and the licensee. • Notes any changes in operation must be authorized by the FERC and properly coordinated between the licensee, FERC, and the operators. • Requires a Final Construction Report within 45 days of completing construction.
September 9, 2004 - November 15, 2004	<ul style="list-style-type: none"> • Liner installed on upstream slope of upper reservoir. • All of the upper reservoir level control and protection devices were replaced. Three GE Druck 1230 transmitters were installed for normal shutdown of the pump/generators. The Low, Low/Low Warrick Conductivity switches are replaced in kind. The High, High/High float

	<p>switches were replaced with Warrick Conductivity probes. The upper reservoir PLC was replaced with an Allen Bradley PLC. The pump/generator shutdown relays at the plant are replaced with Allen-Bradley PLCs. The level indicators, alarming, and data acquisition systems were replaced with a WonderWare Operator Interface. (source: Joe Raybuck’s Draft Taum Sauk Upper Reservoir Level Control and Protection Systems - Information Sheet)</p> <ul style="list-style-type: none"> • Instrumentation pipe supports are changed to cable support system (source: As-built Design Drawings). • Ameren replaced the existing staff gage, which had settled approximately one foot along with the reservoir wall. The staff gage had been used to measure the normal operating level of the upper reservoir, which was 1596 ft. Due to the settling, Ameren believes that the upper reservoir was actually operating at 1595 ft. instead of 1596 ft. before the liner replacement project. (Ameren Chronology) • During the outage new visual level indications were painted on the liner reflecting true elevations. (Ameren Chronology)
October 6, 2004	<ul style="list-style-type: none"> • Geo-Synthetic, Inc. (“GSI”), the installation contractor, raised concerns that the March 7, 2003 gage piping design did not provide for adequate anchoring and could compromise the integrity of the liner and gage piping. In response, Emcon/OWT, Inc. (“Emcon”), an engineering firm retained to design the liner and gage piping, provided a new design drawing (8304-X-155099, Rev. 5, dated 10/5/04) proposing a new gage piping anchoring system. (Ameren Chronology - See Exhibit 8).
October 20-23, 2004	<ul style="list-style-type: none"> • GSI installed the gage piping. (Ameren Chronology - See Exhibit 9). During installation, Ameren determined that Emcon’s design (8304-X-155099, Rev. 5, dated 10/5/04) for the gage piping could not be installed as shown due to field conditions. In consultation with Emcon and with its approval, Ameren made field changes to the anchoring system in order to adapt the design to field conditions and to make it more robust. • Subsequently, on November 12, 2004, Emcon and

	Ameren performed a walk-through inspection of the liner and gage piping installation.
November 6, 2004	<ul style="list-style-type: none"> Ameren field notes reported that the top of panel 72, the lowest known point on the upper reservoir parapet wall, was measured at elevation 1596.99 ft. (Ameren Chronology - <i>See Exhibit 10</i>).
November 8, 2004	<ul style="list-style-type: none"> Ameren field notes reflected that the level protection probes were intended to be installed at the following elevations: Lo-Lo probe: 1524 ft.; Lo probe: 1524.5 ft.; Hi probe: 1596 ft.; Hi-Hi probe: 1596.2 ft. (Ameren Chronology - <i>See Exhibit 11</i>.)
Mid-November 2004	<ul style="list-style-type: none"> The level control transducers and level protection probes were lowered into the gage pipes. Wiring from the transducers and probes to the upper reservoir gage house were marked with colored tape to distinguish one probe from another and to provide an elevation reference. Ameren believes the colored tape reflects the as-designed and installed elevations of the level protection probes. These elevations approximate those indicated in Ameren field notes. (Ameren Chronology.)
November 15, 2004	<ul style="list-style-type: none"> Ameren released the upper reservoir for operation. (Ameren Chronology - <i>See Exhibit 12</i>.) The normal operating level remained at 1596 ft., but now was being measured by the new level control transducers and visual level indications. As a result, the actual normal operating water level was 1596 ft. and not 1595 ft. as it had been prior to the liner replacement project, as further described in the September 10 entry.
November 23, 2004	<ul style="list-style-type: none"> Reference comment logged into the Upper Reservoir Programmable Logic Controller (“PLC”) program indicated that the Hi probe was at elevation 1596 ft. (Ameren Chronology - <i>See Exhibit 13</i>.) Reference comment logged into the Taum Sauk Common PLC program indicated that the Hi-Hi probe was at elevation 1596 ft. (Ameren Chronology - <i>See Exhibit 14</i>.) Ameren believes, but has been unable to verify, that Tony Zamberlan of Laramore, Douglass, and Popham Consulting Engineers (“LDP”), entered the comments. LDP was retained by Ameren to provide engineering services related to the new level control and protection instrumentation.

November 30, 2004	<ul style="list-style-type: none"> • The Hi probe actuated. An Osage operator recorded a trip of unit 2 with the upper reservoir level measuring elevation 1595.0 ft. (Ameren Chronology - <i>See Exhibits 15 and 16.</i>) • Later that day, the Lo Lo probe relay lost DC power and shut down both generators. (Ameren Chronology - <i>See Exhibits 15 and 16.</i>) • An email from Taum Sauk’s plant superintendent listed the shut down setpoints for the upper reservoir. (Ameren Chronology - <i>See Exhibit 16.</i>) When the average of the three level control transducer readings reflects that the upper reservoir level is at the following elevations, the corresponding pump shut downs will occur: <ul style="list-style-type: none"> <li style="padding-left: 40px;"><u>Elevation 1592 ft.</u> Normal shut down for first pump. <li style="padding-left: 40px;"><u>Elevation 1596 ft.</u> Normal shut down for second or last pump. <li style="padding-left: 40px;"><u>Elevation 1596.5 ft.</u> All pumps shut down. • The superintendent also stated that the setpoint for the level protection probes is above elevation 1596.5 ft.
December 1, 2004	<ul style="list-style-type: none"> • To prevent intermittent trips, Tony Zamberlan added a one minute time delay to the PLC logic for all level protection probe relays. (Ameren Chronology - <i>See Exhibits 17 and 18.</i>) • According to Mr. Zamberlan’s Dec. 2nd email, he also was at the upper reservoir to “pull up the Hi level Warrick probes to 1596.5.” (Ameren Chronology - <i>See Exhibit 17.</i>) Mr. Zamberlan does not recall, and has been unable to explain why he set the probes at elevation 1596.5 ft., or how he determined that elevation. • Reference comment logged into the Upper Reservoir PLC program indicated that the Hi probe was at elevation 1596.7 ft. Ameren believes, but has been unable to verify, that Mr. Zamberlan entered the comment. (Ameren Chronology - <i>See Exhibit 18.</i>)
December 10, 2004	<ul style="list-style-type: none"> • LDP finalized and issued the schematic drawing for the

	<p>upper reservoir level relaying and shut down controls (8303-P-26648, revision 15). (Ameren Chronology - See Exhibit 19.) The schematic indicated that the Hi probe was at elevation 1596.7 ft. and the Hi-Hi probe was at elevation 1596.9 ft. LDP personnel do not recall, and are unable to explain why the drawing reflects the stated elevations.</p>
<p>December 14, 2004</p>	<ul style="list-style-type: none"> • Pump shutdown levels are indicated in the Taum Sauk PLC. When the average of the three level control transducer readings reflects that the upper reservoir level is at the following elevations, the corresponding pump shut downs will occur: <ul style="list-style-type: none"> <u>Elevation 1592 ft.</u> Normal shut down for first pump. <u>Elevation 1596 ft.</u> Normal shut down for second or last pump. <u>Elevation 1596.2 ft.</u> Normal all pumps shut down. <u>Elevation 1596.5 ft.</u> Non-configurable all pumps trip that, if activated, requires a reset. <p>(Ameren Chronology - See Exhibit 20.)</p> • Reference comment logged into the Taum Sauk Common PLC program indicated that the Hi-Hi probe was set at elevation 1596.5 ft. Ameren believes, but has been unable to verify, that Mr. Zamberlan entered the comment. (Ameren Chronology - See Exhibit 20.)
<p>December 20, 2004</p>	<ul style="list-style-type: none"> • Ameren sends to letter to D2SI-CRO in response to comments on the 8th Part 12D Report. As an attachment, Ameren includes the latest survey of the crest (taken November 2003 and corrected October 2004) and drawings and diagrams of the new Upper Reservoir Level Controls. The Schematic Diagram (revised on 12/10/2004) shows the Hi Warrick Probe set at 1596.7 feet and the Hi-Hi Probe set at 1596.9 feet. The design drawing of the instrument supports shows only three pipes.

Fall 2004???	<ul style="list-style-type: none"> • Do we know when epoxy was installed in the tunnel crack??? Was this the same time as liner work?
December 27, 2004	<ul style="list-style-type: none"> • A malfunctioning Lo-Lo probe relay was replaced. (Ameren Chronology - <i>See Exhibit 21.</i>) • The PLC historian software recorded a Hi-Hi probe alarm at 3:38 p.m. PST, or 5:38 CST, at an upper reservoir level reading of elevation 1586.4 ft.¹ (Ameren Chronology - <i>See Exhibit 22.</i>) At the time of the alarm, the units were neither pumping nor generating. (Ameren Chronology - <i>See Exhibit 23.</i>) • Ameren believes this alarm may have been associated with maintenance activities at Taum Sauk.
January 5, 2005	<ul style="list-style-type: none"> • Ameren sends letter to D2SI-CRO showing leakage rate has significantly decreased since installation of liner (from around 50 cfs to around 15 cfs). • Indicates diver will seal all remaining leaks in the floor area during the Spring or Summer.
February 12, 2005	<ul style="list-style-type: none"> • Ameren sends letter to D2SI-CRO including the final construction report for the liner replacement. The report includes gage piping drawing (8304-X-155099, Rev. 5, dated 2/7/05) which does not identify the field changes made to the gage piping anchoring system. (Ameren Chronology - <i>See Exhibit 24.</i>)
February 14, 2005	<ul style="list-style-type: none"> • The PLC historian software recorded a six-second Hi-Hi probe alarm at 3:57 p.m. CST, at an upper reservoir level reading of elevation 1593.5 ft. (Ameren Chronology - <i>See Exhibit 22.</i>) At the time of the alarm, the units were neither pumping nor generating. (Ameren Chronology - <i>See Exhibit 25.</i>) • Ameren believes this alarm may have been associated with maintenance activities at Taum Sauk.
February 15, 2005	<ul style="list-style-type: none"> • The PLC historian software recorded multiple Hi-Hi probe alarms between 4:03 p.m. and 5:49 p.m. CST, at an upper reservoir level reading of elevation 1593.5 ft. (Ameren Chronology - <i>See Exhibit 22.</i>) At the time of the alarms, the units were neither pumping nor

¹ On the date of the alarm, the PLC Historian software was programmed to Pacific time. In June 2005, the PLC Historian software was reprogrammed to Central time. Throughout this chronology, all noted alarms recorded by the PLC Historian software are expressed in Central time.

	<p>generating. (Ameren Chronology - <i>See Exhibit 25.</i>)</p> <ul style="list-style-type: none"> • These alarms were associated with functional checks of the Hi-Hi probe alarm that were performed by a contractor at the direction of Ameren personnel. The contractors lowered the Hi and Hi-Hi probes into the water. • The generator trip logic for the Lo and Lo-Lo probes was modified from parallel logic to series logic by Tony Zamberlan. (Ameren Chronology - <i>See Exhibits 26 and 27.</i>) In series logic, the generators would only shut off if both the Lo and Lo-Lo probes actuate. A similar change was made by Mr. Zamberlan to the pump trip logic for the Hi and Hi-Hi probes. Ameren believes the generator trip logic for the Lo and Lo-Lo probes was modified to prevent spurious actuations. Ameren has been unable to determine why the pump trip logic for the Hi and Hi-Hi probes was modified. T. Zamberlan stated the changes were made for consistency sake.
July 20, 2005	<ul style="list-style-type: none"> • The PLC historian software recorded a one-second Hi-Hi probe alarm at 5:15 p.m. CDT, at an upper reservoir level reading of elevation 1573.8 ft. (Ameren Chronology - <i>See Exhibit 22.</i>) At the time of the alarm, the units were generating. (Ameren Chronology - <i>See Exhibit 28.</i>) • Ameren has been unable to determine why this alarm was recorded, but around the time of the alarm, a storm, likely accompanied by lightning, moved through the area of the project works. The storm may have caused momentary induced voltages on the wiring running between the Hi-Hi probe relay and the plant PLC input card resulting in the PLC Historian recording a false Hi-Hi probe alarm.
August 14, 2005	<ul style="list-style-type: none"> • The PLC historian software recorded a one-second Hi-Hi probe alarm at 3:50 p.m. CDT, at an upper reservoir level reading of elevation 1591.6 ft. (Ameren Chronology - <i>See Exhibit 22.</i>) At the time of the alarm, the units were generating. (Ameren Chronology - <i>See Exhibit 29.</i>) • Ameren has been unable to determine why this alarm was recorded, but at the time of the alarm, a storm, accompanied by lightning, moved through the area of the project works. The storm may have caused momentary induced voltages on the wiring running between the Hi-Hi probe relay and the plant PLC input card resulting in the PLC Historian recording a false Hi-Hi probe alarm.

September 25, 2005	<ul style="list-style-type: none"> • Remnants of Hurricane Rita pass through area. • Workers witness overtopping, referred to as “Niagara Falls at the Northwest corner of the reservoir” • Units are immediately put on generate mode to lower reservoir. (source: 9/27/2005 email from Richard Cooper) • Refer to September 24-26 Operations Time Line
September 27, 2005	<ul style="list-style-type: none"> • The plant superintendent notes the visual level of the reservoir (as measured down from the crest of the parapet wall) does not match the average transmitter level. The visual level was about 4 inches from the top of the parapet wall near “a couple of wet areas on the west side of the reservoir parapet walls”, even though the transducers were showing elevation 1596 feet. <i>(Note: if the referred to west area was around panel 72, which is the lowest panel on the west side of the dam – 4 inches from the top of the crest would be elevation 1596.66 feet.)</i> • One transmitter is found to be reading “a foot higher than the other two” and is eliminated from the average, leaving two transmitters. When the one transmitter was taken out of the average, the reading was 1596.2 feet. Since this did not match the elevation in the field, a 0.4 (foot) adjustment was made to the two remaining transmitter readings, making the level read 1996.6 feet. • The plant superintendent states they would “check on what this does to the actual level the next several mornings.” (source 9/27/2005 email from Richard Cooper) • At 10:11 a.m., an Osage operator noted in the operator log a “high upper resv. alarm [and] small gate setting changed to 7.7% by itself. HPT’s are working on something @ Sauk.” (Ameren Chronology - See Exhibit 31.) At the time the notation was made, the units were neither pumping nor generating. Ameren believes this alarm is related to work being done on the PLC at approximately the same time. (Ameren Chronology - See Exhibit 22.) Between 10:03 and 10:05 a.m.,

	<p>the elevation level readings for the upper reservoir were not recorded, suggesting that the PLC was offline so that an adjustment to the logic could be made. The adjustment may have resulted in an alarm indication once the PLC came back online.</p>
September 28, 2005	<ul style="list-style-type: none"> • The PLC historian software recorded a one-second Hi-Hi probe alarm at 6:18 p.m. CDT, at an upper reservoir level reading of elevation 1544.1 ft. (Ameren Chronology - <i>See Exhibit 22.</i>) At the time of the alarm, the units were neither pumping nor generating. (Ameren Chronology - <i>See Exhibit 31.</i>) • Ameren has been unable to determine why this alarm was recorded, but at the time of the alarm, a storm, accompanied by lightning, moved through the area of the project works. The storm may have caused momentary induced voltages on the wiring running between the Hi-Hi probe relay and the plant PLC input card resulting in the PLC Historian recording a false Hi-Hi probe alarm.
September 30, 2005	<ul style="list-style-type: none"> • The Hi and Hi-Hi Warrick Probes are verified to be 7 inches and 4 inches below the crest of the wall, respectively. (<i>Note: This results in elevations 1597.417 ft and 1597.667 ft, respectively, based on the recent survey of the parapet wall near the instrumentation.</i>) (Source: 10/7/2005 email from Thomas Pierie and Ameren Chronology.)
October 3-4, 2005	<ul style="list-style-type: none"> • A visual inspection of the upper reservoir revealed that portions of the gage piping support system had failed, allowing the gage piping to move. The piping was observed to be bent. Ameren operators recognized that a bend in the piping would produce an elevation reading that is lower than the actual elevation of the upper reservoir. (Ameren Chronology - <i>See Exhibit 33.</i>)
October 6, 2005	<ul style="list-style-type: none"> • The plant superintendent notes the pvc pipes have come loose from the cables and are bowing at least 5 feet out at about 50 feet down. • In the evening, Unit 1 tripped in the generate mode due to high vibrations. (Source: 10/7/2005 email from Richard Cooper)
October 7, 2005	<ul style="list-style-type: none"> • The maximum operating level is set at 1594 feet instead of the normal 1596 feet. • The set point for the “all pumps” shutdown was lowered from elevation 1596.2 ft. to elevation 1594.2 ft. (Ameren Chronology)

	<ul style="list-style-type: none"> • Arrangements are made to have a diver evaluate whether the piping could be straightened and reattached without draining the reservoir (Ameren Chronology – <i>See Exhibit 34</i>). • Plans were made to add redundancy to the upper reservoir level protection system. A wind speed measurement, transmitter and alarm, were ordered for installation at the upper reservoir. Ameren also planned to install an additional probe 2” below the normal last pump shut down setpoint (<i>i.e., at elevation 1595.83 ft.</i>) so that the level transmitters could be checked. (Ameren Chronology - <i>See Exhibit 32.</i>) • In the morning, Unit 2 tripped on high vibration in the pump mode. • The plant superintendent believes some epoxy material is coming loose from the tunnel liner that was installed last fall. The epoxy was installed in the tunnel to cover cracks in the steel liner. The size of the epoxy patch was about 1 inch thick, 6 feet wide and 100 feet long. The tunnel drains were found to be flowing at full pipe link they were before the epoxy patch was installed. The vibration protection trips on the units were set to normal levels and the superintendent believed these would protect the units if more material is released. (Source: 10/7/2005 email from Richard Cooper)
October 11, 2005	<ul style="list-style-type: none"> • A diver visits the site and says the pipes can be straightened out but Ameren needs to develop/manufacture a new tie down system. (Source: 10/11/2005 email from Richard Cooper)
October 25, 2005	<ul style="list-style-type: none"> • The preliminary design was completed and materials were ordered for the gage piping support retrofit. (Ameren Chronology - <i>See Exhibit 35.</i>)
November 2, 2005	<ul style="list-style-type: none"> • The PLC historian software recorded a nine-second Hi-Hi probe alarm at 12:49 p.m. CST, at an upper reservoir level reading of elevation 1578.4 ft. <i>See Exhibit 22.</i> At the time of the alarm, the units were neither pumping nor generating. (Ameren Chronology - <i>See Exhibit 36.</i>) Ameren has been unable to determine why this alarm was recorded.
November 23, 2005	<ul style="list-style-type: none"> • All materials are on hand to make repairs. • Emails indicate Ameren is having trouble

	scheduling repairs and notes the diver may not be available through the end of the year. (Source: 11/23/2005 email from Steven Bluemner)
December 13, 2005	<ul style="list-style-type: none"> • Operations data shows the transmitter elevations drop about 1.9 feet at about 11:20 pm although both units are pumping. (Source: Ameren's Operation Data) • See December 13-14 Operations Time Line
December 14, 2005	<ul style="list-style-type: none"> • Dam Overtops and Breaches • See December 13-14 Operations Time Line

6.2 Events of September 24- 26, 2005 Overtopping due to the Remnants of Hurricane Rita

**September 24-26 Operations Time Line
Taum Sauk Project, P-2277**

Date	Time	Transmitter Elev. (ft)	Unit Info.	Weather at Farmington, MO	Coincident Events
Sept. 24	13:00	1595.82	Generator 1 on-line	Wind 8 knots coming from 110 degrees of North, Clear	
	13:11	1595.03	Generator 2 on-line	Same	
	18:01	1544.91	Generator 1 off-line	Wind 5 knots coming from 100 degrees of North, Clear	
	18:02	1544.91	Generator 2 off-line	Same	
	18:58	1544.75	Generator 2 on-line	Wind 4 knots coming from 110 degrees of North, Clear	
	19:01	1544.20	Generator 1 on-line	Same	
	20:01	1532.00	Generators 1 & 2 off-line	Wind 6 knots coming from 110 degrees of North	
Sept. 25	00:27	1531.65	Pump 2 on-line	Wind 3-4 knots coming from 30-120 degrees of North	
	01:57	1539.80	Pump 1 on-line	Wind 5 knots coming from 70 degrees of North	
	08:03	1592.11	Pump 2 off-line	Wind 9 knots (gust to 16 knots) coming from 80 degrees of North, precip.	
	9:03	1595.96	Pump 1 off-	Wind 14 knots	Ameren

		line	(gust to 20 knots) coming from 80 degrees of North, precip.	guards note overtopping during this period.
	11:03	1595.97	Generator 2 on-line	Wind 8 knots coming from 100 degrees of North, precip.
	12:15	1590.92	Generator 2 off-line	Wind 8-9 knots coming from 80-100 degrees of North, precip.
	13:56	1590.85	Generators 1 & 2 on-line	Wind 7 knots coming from 140 degrees of North, precip.
	18:03	1547.91	Generators 1 & 2 off-line	No wind, slight precip.
	18:59	1547.78	Generator 1 on-line	No wind
	19:01	1547.68	Generator 2 on-line	Same
	20:35	1528.18	Generator 2 off-line	Wind 3 knots coming from 310 degrees of North
	20:59	1525.80	Generator 1 off-line	Same
	21:58	1525.42	Pump 2 on-line	Wind 7 knots coming from 350 degrees of North
	23:01	1531.49	Pump 1 on-line	Same
Sept. 26	05:53	1591.96	Pump 2 off-line	Wind 3 knots coming from 300 degrees of North, Clear
	06:43	1594.9	Pump 1 off-line	Wind 5 knots coming from 260 degrees of North, Clear

* Information for this chart is from Ameren's operation data & Metar Data provided by National Weather Service.

6.3 Events of December 13 and 14 2005

December 13-14 Operations Time Line Taum Sauk Project, P-2277

Date	Time	Transmitter Elev. (ft)*	Unit Info.	Weather at Farmington, MO	Coincident Events
Dec. 13	06:05	1591.52	Generator 1 on-line	36 ^o , Wind at 5 knots coming from 60 degrees from North	
	06:06	1591.54	Generator 2 on-line	Same	
	7:08	1581.57	Generators 1 & 2 off-line	34 ^o , No wind	
	16:43	1581.29	Generator 1 on-line	43 ^o , Wind at 3 knots coming from 180 degrees from North	
	16:50	1580.63	Generator 2 on-line	Same	
	20:06	1548.08	Generator 1 off-line	45 ^o , Wind at 9 knots coming from 160 degrees from North	
	20:27	1546.39	Generator 2 off-line	45 ^o , Wind at 11 knots coming from 180 degrees from North	
	22:33	1546.85	Pump 1 on-line	43 ^o , Wind at 11 knots coming from 160 degrees from North	
	23:13	1548.59	Pump 2 on-line	41 ^o , Wind at 8 knots coming from 140 degrees from North	At about 23:20 there is a 1.9 foot drop in the transmitter readings, although both pumps are

					operating.
Dec. 14	04:43	1591.85	Pump 2 off-line	39 ^o , Wind at 8 knots coming from 150 degrees from North	
	05:16	1593.39	Pump 1 off-line	39 ^o , Wind at 16 knots coming from 160 degrees from North	Between 5:15 and 5:30, USGS Gage 07061270 (East Fork Black River Near Lesterville) located near Highway N was damaged by the flood surge.
	05:20	1581.59			
	05:25	1548.09			
	05:30	1522.52			
	05:35	1510.78		39 ^o , Wind at 13 knots (gust to 19 knots) coming from 170 degrees from North	At 5:38, the Osage Operator logs that the upper reservoir indication, tailwater level indication, and generate permissives were not reading normal on the LDS and STADA System
	05:40	1507.00			At 5:40, Osage Operator notifies Taum Sauk Superintendent of unusual readings. At 5:41, the Reynolds County 911 dispatcher

				received a call about water on Highway N.
05:45	1505.72			
05:50	1505.12			
05:55	1504.77			
06:00	1504.55		37 ^o , Wind at 11 knots (gust to 16 knots) coming from 160 degrees from North	At 6:00, the plant superintendent confirms tailrace is muddy. The Lesterville Fire Department and Reynolds County Sheriff contact the Plant Superintendent to confirm the upper reservoir dam has breached. The plant superintendent begins contacting others on EAP.
08:00	1503.52		36 ^o , Wind at 8 knots coming from 150 degrees from North, slight precip.	

* Transmitter readings are not the true elevations of reservoir.

** Information for this chart is from Ameren's operation data, NOAA's thrice hourly surface climate data for Farmington, MO Airport Station, Ameren's 12.10 letter, an interview with Reynolds County Sheriff, and a 1/23/2006 email from USGS.

Appendix C

Early Project Correspondence

A. Depressed Area Floor

A. Reasons for excessive leakage

1. Leakage from this area has been excessive from September, 1963 to April 1964 as shown by visible leaks on outside.

B. Contrary evidence

None

C. Corrective measures

1. Early in September 1963, a sudden increase in leakage up to 103 cfs occurred, most of which appeared outside opposite the depressed area. Reservoir was drained September 5th and 6th, and two holes in floor at Panels 91 and 92 were filled with concrete.
2. After the above repair, leakage was reduced to about 25 cfs at a comparable elevation. About three days later another sudden increase in leakage caused the reservoir to be drained for further repairs. Large voids were observed under the floor and toe block where erodible material had been washed out. This condition was observed by J. Barry Cooks, and on his recommendation a four foot wide trench was excavated to "sound rock" in front of the toe block at Panels 93 to 90 to 93 and at 95. This trench, about 330 feet long and varying in depth from two feet to 16 feet was filled with concrete and covered with 2" of hot-bit asphalt. In addition approximately 200 grout holes 10 feet deep were drilled through the toe block apron and poured full of grout. After this repair the leakage was considerably reduced, but was still in the range of 35 to 40 cfs. with pool at 1580.
3. By November 4, 1963, leakage had increased to 38 cfs at 1584, and reservoir was again drained for repairs. A long crack was discovered in the asphalt floor at Panels 91 and 92, and additional voids and washed out areas were found under the floor and toe block. Voids were cleared out and filled with concrete. A grout curtain was placed from panel 95 to 90 along the cut-off wall and thence across the floor to panel 107. 30 ft. holes on 10 ft. centers were pumped full of asphalt underseal, and then intermediate holes 30 ft. deep were drilled and pressure grouted with cement. After this repair, reservoir leakage was reduced to about 35 cfs at a comparable head.

IMG128331

4. Repaired Area Floor (Continued)

C. Corrective actions

4. On January 31, 1964, leakage had increased to 55 cfs at elevation 1585. Reservoir was drained and it was found that crack in front of cut-off wall was opened up for about 100 ft. at points 90-91. This was covered with old conveyor bolting held down by 4 inches of concrete reinforced with wire mesh. Reservoir was filled before all concrete was set up, and part of the repair was washed out. Leakage after this repair was about 44 cfs at a comparable head.

5. In March, 1964, (leakage was 59 cfs at 1596 pool) reservoir was drained for repairs. Crack along cut-off wall was again evident. This crack was covered with conveyor bolt placed on a 2" bed of soft concrete, and then covered with a reinforced concrete slab 10" thick and a minimum of 10 ft. wide. Additional holes were drilled and pressure grouted along this slab and partially along the line of old grout holes placed in November.

After this repair, reservoir leakage was reduced to 27 cfs at a 1596 pool.

D. Subsequent observations

1. After the final repair in April, 1964, visible leakage outside the reservoir in this area was reduced to a relatively small value - about 1 to 2 cfs. This leakage has not increased significantly since that date.

J. BARRY COOKE
CONSULTING ENGINEER
253 LAUREL GROVE AVENUE
KENTFIELD, CALIFORNIA 94904

TELEPHONE (415) 454-9331
CABLE: COOKE, KENTFIELD, CALIF.

August 19, 1967

Mr. John K. Bryan, Chief Engineer
Union Electric Company
1901 Gratiot Street
St. Louis, Missouri 63166

TAUM SAUK UPPER RESERVOIR
REPORT ON SAFETY

RECEIVED

AUG 28 1967

JOHN K. BRYAN

Dear Mr. Bryan:

I have reviewed the performance data furnished with Ray Weldy's letter of June 26, 1967, inspected the dam with Frank Drake, Paul Pickel and Ray Weldy on August 15th and engaged in discussions with Union Electric engineers on August 16, 1967. The purpose of my review was to evaluate the safety of the dam and make recommendations for any work that I considered necessary to improve safety.

Conclusion

Based on my knowledge of design and construction, review of performance data, and site inspection, I see no feature where work is required to improve safety. The dam and foundation could safely withstand much greater leakage than has occurred to date, and could withstand more leakage than could be visualized to conceivably occur.

Crest Settlement (Vertical)

The crest settlement after 1 yr - 8 months, six months after the first complete filling, the settlement was higher than normal but quite acceptable, the range of readings being 0.3 to 0.6 feet. In the next 1 yr. - 6 mo. the rate of settlement decreased. However, in the last two 8 month intervals of readings the settlement has been more than in the preceding 8 months. It has been 0.06 to 0.08 ft. in each 8 month period, a rate of nearly 0.10 ft./year.

IMG031306

The 0.10 ft/year rate for a 100 ft high dumped rockfill after 4.5 years of service is high, and unexpected. It would cause joint and face trouble as well as freeboard impairment in several to 10 years. There is nothing that can be done except to continue to observe the rate of movement and hope it decreases.

The vertical crest settlement in 4.5 years (Nov. '62 - June '67) has been about 0.5 ft (0.53% height) for 94 ft height at axis, and 0.8 ft (0.73% height) for 110 ft height. Maximum has been 0.98 ft for 141 ft ht. (0.70% height). These movements in the 4.5 year period are high. The slab and parapet has satisfactorily accepted them.

The settlement on the whole perimeter is similar and reasonably related to height. It does not show any pattern with respect to curvature of the axis of the dam. It therefore appears that the continuing high rate of settlement is a characteristic of this particular rockfill or a consequence of the repeated reapplication of load on a dumped rockfill.

The Taum Sauk rhyolite porphyry is an excellent high compressive strength rock that should have stabilized in its settlement. However, the formation contained frequent zones of soft weathered rock, all of which could not have been selectively wasted. The frequent cycling of the water load should not cause continued adjustment of competent rock but would affect the poor rock. Actually, there is no other experience with such frequent cycling of load on a dumped rockfill, and whether a dumped rockfill of all sound rock would have stabilized by this time is not known. I believe a fill of 100% competent rock would have stabilized and that the percentage of weathered rock in the Taum Sauk is the cause.

Crest Elongation

The crest lengthens when the center of curvature of the axis is in the reservoir. It has been computed that between panels #40 and #67 (1260 ft) the lengthening has been 15 inches, which is 1 in 1000. This stretch or loosening of the fill is associated with slightly higher settlement and could be visualized to cause continued settlement. The movement to date has opened some joints to their limit, which is a problem, but I don't see this feature as a cause of continuing settlement.

This tension or stretch of rockfill occurs in dams that have a bend in the axis (a bend that gives a central angle in the reservoir of less than 180°), and it occurs in the rockfill on steep dam abutments. Relief

Dam (California) and La Jole Dam (British Columbia) both are concrete face dams with "adverse" angles in the axis. They have opened cracks at the junctions, which cracks essentially stopped moving after several years. On high rockfill dams there is a stretch in line with the axis in the one-fourth of crest length near each abutment, and a compression or shortening in the central portion of the dam. The lengthening has been measured at 1 in 300 to 1 in 500 at Mud Mountain, Akosombo and other 300 ft high rockfill dams. The stretch is accompanied by a higher settlement but the settlement does essentially stop.

Parapet Wall

The storage of 8 ft of water on the 10 ft parapet wall is more than has been experienced before. Measurements and visual observations indicate the 6300 ft long wall to be performing very well, and the relative movements to be small.

Panel joint spacing. Joints were initially constructed to 1 inch open. Most have opened, due to the curvature of the axis. The amount of opening has been nominal 1/4 to 1/2 inch except for about 10 of the 111 joints which have opened more than 1 inch. Only several have approached 2 inches and required an inner seal to be installed. Closing of joints has been small and has given no problem in leakage or repair work. The opening of joints in itself would accept 3 inches or more, but combined with a small vertical offset wrinkles occur that cause tears and consequent leakage before joint is fully opened. Future joint opening combined with vertical offsets, it appears, will require further repairs.

Horizontal Panel Misalignment at Joint. On March 10, 1966, offsets were on the order of 1/4 inch with several near Panel #88 at 1 to 1.5 inches. In the 6 month period to September 20, 1966, the movements were generally 1/8 to 1/4 inch with nearly half being in a direction to decrease the offset. This is favorable. There is no indication of trouble developing in these small and in many cases restoring movements.

Vertical Deflections of Parapet Wall. These measurements give the amount the walls are out of plumb. The measurements show the walls to be remaining remarkably plumb. Changes Sept. '63 - Sept '66 indicate about half tilting outward and more than half tilting inward, the amounts out of plumb being usually 1/8 to 1/4 inch, with few being as much as 1/2 inch.

Cracks. All of the 60 ft long parapet panels seem to have settled more at the center than at the edges. This is evidenced by vertical cracks at about 10 ft spacing that start at the bottom and stop about 5 to 6 ft up on the 10 ft wall. In two slabs spalling has occurred near the top and center, indicating high compressive stress. It is possible that the shear at the base of the 10 ft wall has caused slight movement and the leakage in the Panel 10 to 25 area, in combination with a poor cold joint. Otherwise, this "phenomena" has caused no trouble. It is probable that the redistribution of water load on the rock by the stiffness of the wall & its base will keep relative settlement compatible with the stresses in the parapet wall and base slab. I don't know why this stress and differential settlement occurs, but there must be a reason since it is so consistent among all panels.

Crest Road - Berm Sloughing

Sloughing of the berm of the crest road has occurred in the Panel 43 to 63 area, the deepest sloughs being in areas of Panels 50-51-52. At Panels 50-52 the sloughs removed as much as 6 ft of the 12 ft road, and they caused a surface slide that piled up some rock at the toe of the rockfill. This is a surface stability problem only and has now taken care of itself. It could only have happened due to excessive fines in the top of the dumped fill and in the four 4 ft lifts above the top of the dumped rockfill.

The Panel 43 to 63 area was the last zone of the dam that was completed and excessive fines were known to have been included in the rockfill. Excavation for the hand dry rock masonry, in restoring the berm, was in fine material. The top of the dumped rockfill, 16 ft below the crest would be impervious. Leakage above that level and rainfall could saturate the upper zone of the dumped rockfill as well as some of the 4 ft layered rock with excessive fines. Local sloughing would be possible under these conditions. The local nature of what occurred compared to the 60 ft width of slab and the dimensions of the rockfill make it impossible to imagine any hazard to the crest of the dam, other than maintenance for roadway width.

Leakage

The reservoir leakage is now 8 cfs, which is substantially lower than the high leakages associated with problems in the initial operating period. The downstream toe of the dam and the foundation in that area were inspected. The leakage channels have never caused erosion of consequence and the saturation has not caused slides or any indication

Mr. John K. Bryan

- 5 -

August 19, 1967

of potential slides. From the known conditions of the foundation and the dam, and from the inspection, there is no stability problem due to the leakage. The base of the rockfill is of large sound rock, as segregated during the process of dumping from the high lift, and could safely take hundreds of cfs leakage.

Proposed October 1967 Shutdown

The reservoir will be unwatered for work on the spherical valve. The shutdown will be for about 3 weeks. Any work on the dikes and reservoir floor during that time would be as determined to be economical in reducing present or future leakage. No work is necessary to improve safety beyond the present adequately safe conditions.

Sincerely yours,

Barry Cooke

JBC:dm

IMG031310

UNION ELECTRIC COMPANY
1501 GRATIOT STREET
SAINT LOUIS, MISSOURI 63166

August 9, 1968

MAILING ADDRESS:
P. O. BOX 149
SAINT LOUIS, MISSOURI 63163

Mr. J. Barry Cooke
Consulting Engineer
253 Laurel Grove Avenue
Kentfield, California 94904

Dear Barry,

TAUM SAUK PROJECT UPPER RESERVOIR
F.P.C. SAFETY REPORT

Mr. Vencill and I have talked about your letter of July 26, and we have decided that we should maintain that the controls and alarms are reliable and no spillway or overpour provisions are needed. That is the position we have maintained from the beginning. If the F.P.C. should reverse their present Taum Sauk stand, in view of spillway requirements for recent projects, then we could ask you for an additional study and recommendation. In this you could bring out your recommendations that you have made for the safety of the parapet from overpour and the safety of the rockfill from erosion.

The plant is unattended and is operated automatically from our Osage Plant (103 miles distant) over microwave channels. Maintenance men are on duty from 8:00 A.M. to 4:30 P.M. five days a week and one or two men keep the visitors' center cleaned up on Saturday and Sunday. A Pinkerton guard is on duty from 6:30 A.M. to 6:30 P.M. every day of the year. He makes numerous trips to the reservoir area and would notice any overpour if it extended beyond 6:30 A.M. The normal procedure is to pump back with only one pump, and shutdown varies from 3:00 A.M. to 5:00 A.M. On the few occasions when two pumps are used, shutdown is seldom before 6:30 A.M.

The normal procedure is to rely on the automatic controls with any backup that is provided. If these fail, then an "urgent alarm" is transmitted to the Osage Plant and a maintenance man is called out. It takes him 30 minutes to an hour to reach the plant depending on the distance he has to travel.

The pump shutdown controls operate as follows. The surface detector (headwater gage) is actuated by a displacer that follows the water's surface in an inclined pipe. The instrument (made by Leupold & Stevens) has three built-in shutdown switches that operate at elevation 1595, 1596 and 1597. The first switch operates to shutdown the first pump (when two are operating) at elevation 1595. The second operates to shutdown the second pump (or either pump if only one is operating) at elevation

Live Better . . .



. . . Electrically

IMG031325

1596. Shutdown takes about six minutes and the reservoir rises an additional 0.25 foot after the switches operate. The third switch operates at elevation 1597. This is a backup switch that shuts down either or both units if the first two switches fail to operate properly. Complete shutdown occurs in about 2.5 minutes after this switch operates.

In case of power failure to the surface detector an "urgent alarm" signal is received at Osage and there is a call out to determine the trouble. There is a separate set of float switches which operate in case the surface detector fails from any cause. These backup switches are in a separate float mechanism which is mounted over a stilling well on the inside of the parapet wall. These switches are all set to operate at levels 0.1 foot above the normal shutdown switches. If the first or second switch should operate (elevation 1595.1 and 1596.1) a target shows up on the annunciator panel and the trouble is corrected during the normal day shift. If the first two backup switches should fail to operate, the third switch will operate at elevation 1597.1 and will trip the circuit breakers and shut the unit or units down immediately. A lockout will occur and the units cannot be started as a pump or generator until a maintenance man corrects the trouble.

All six of the switches are wired for fail-safe operation. They are normally closed and operate at 125 volts D.C. If any circuit from the plant to the reservoir opens up due to any cause including lightning blowing a fuse, the unit or units automatically shut down. If the units are not operating, the automatic controls prevent starting as a pump or generator.

Another safety feature is that an "urgent alarm" is received at Osage when the total volume of water falls below about 4,300 acre feet. The volume controller would get this indication if there was a mechanical failure that would keep the surface detector from following the water level upward. However, there would be no "urgent alarm" signal in the top 11 or 12 feet because we operate with 4800 AF in the system under the assumption the last 10 feet of water will not be drawn out of the upper reservoir.

There is also a provision for automatic shutdown of each unit in case of low tailwater (low^r reservoir) level. A float switch connected to the draft tube of Unit No. 2 will shut it down when the pumping level in the draft tube reaches 726. A similar switch will shut down Unit No. 1 at elevation 725. The velocity head at the throat of the draft tube is 786 feet with a pumping rate of 2,000 c.f.s. with full upper reservoir, and the friction loss may be as much as one foot. This makes a total head loss of about 9 feet which means that No. 2 and No. 1 pumps would not pump much below a lower reservoir elevation of 735 and 734 respectively before automatic shutdown would occur. The exact elevation has never been determined. The float switch for No. 2 Unit was set to operate at a draft tube water level when cavitation just began to occur as indicated by a loud popping sound. No. 1 Unit was set to operate one foot lower. During

the early days of operation, before the binwall dam was constructed across the East Fork of the Black River, a flood washed gravel into the excavated channel and partially restricted it so there was considerable drawdown when pumping at low pool level. The float switches were installed then to prevent pumping at low levels where cavitation occurs.

There is an indicating upper reservoir level meter in both the Load Dispatcher's Office in St. Louis and the control room at Osage. Men at both of these places watch these meters but do not record levels each hour. Also they have a general feel of how long the pump or pumps should run, and it is inconceivable that either of them could let the pumps run very long after the reservoir is full without noticing that they had failed to stop.

Now I will comment on your ideas for making the parapet and rockfill safe from overpour. You asked the following question. Assuming pumping continued and there was no lower reservoir inflow, how long would it take to drain the lower reservoir? Right now with the upper reservoir full (1596.25), the lower reservoir is at elevation 736.25. If the automatic controls in the upper reservoir failed to shut down both pumps, then they would continue to pump until the float switches attached to the draft tube shut them down. The upper reservoir would rise to elevation 1598.43, the elevation of the lowest parapet (No. 95), and then start to run over the top. This is not actually the elevation but is the comparative elevation with Panel 58 where the gage is located. After the water started to flow over the top, it would continue to flow over more and more parapets for about 20 minutes when Pump No. 2 would shut down with the lower reservoir at elevation 735. No. 1 pump would continue pumping 2,000 c.f.s. for another hour before it would shut down when the lower reservoir reached 734. If both pumps failed to shut down, they theoretically could pump until they ran out of water with the lower reservoir down to 724, the bottom of the excavated channel. However, the pumps would begin to experience a shortage of water at a higher elevation of say 730 due to the slope in the channel. The volume between 736.25 and 730 is 1130 AF and it would take 3.4 hours to pump this amount at the rate of 4,000 c.f.s. All of the overpouring water from the parapet would return to the lower reservoir in perhaps an hour, then there would be a continuous recirculation system and the lower reservoir could never be emptied.

I like your idea for deflectors to aerate the overflow of the parapet and the caps to limit the overflow to one c.f.s. per foot. We already have deflectors (one-foot concrete blocks) on Panels 5, 10, 15, 20 and 58 which were installed for another purpose. Additional deflectors and caps could be installed at a fairly nominal cost, I believe. They could be made out of half hard aluminum sheets (like we used over expansion joints for repairs) bolted to the outside of the parapet with cinch anchors. However, if this is done it will shorten the length of overflow and increase the head and flow per foot of length. We will run another

August 9, 1968

computation on this to determine the pool elevation using your suggestion for capping about 62 panels. In the meantime we will give consideration to your suggestions and there is the chance that we can work it in with some maintenance at a later date, say in 1969.

We would like to review the draft copy of your Upper Reservoir Report as soon as you finish it. We are getting to the point now where we would like to file your report with the F.P.C. as soon as it can be done conveniently.

If you will send us the original of your final report, we will make the nine additional copies which we will need. This includes one copy which we will return for your use.

Incidentally, Mr. Jack Shepley of the F.P.C. Washington Office called Mr. Vencill recently and asked for information about the upper reservoir level detection and pump shutdown which I sent him. He is writing an A.S.C.E. paper and I presume he will cover most of the licensed projects. I told him there would be no structural damage if the pumps failed to shut down, but there would be some washing of the roadway surface.

Very truly yours,

Raymond N. Weldy

Raymond N. Weldy
Sr. Supervising Engineer
Hydraulic Engineering

mgw

cc: Messrs. M. W. Fleer
E. W. Nielson ✓

IMG031328

May 22, 1970

Mr. E. Dille

Towne Seuk Upper Reservoir Leakage

The computed leakage for the period April 9, 1970 through May 14, 1970 is 13.13 cfs which is a numerical increase of 1.42 cfs from the previous period. However, during this period the leakage has had an additional head of six (6) feet. This increase in leakage had been anticipated when raising to the summer elevation.

The Monthly Inspection of the Upper Reservoir Rockfill was made on May 13, 1970; no significant structural changes were noted. There were several small washes noted in the "fine" fill area between panels 88 through 110 because of the recent heavy precipitation.

Original Signed By M. W. FLEER

M. W. Fleer
General Superintendent
Cedar & Towne Seuk Plants

RJM/jad

cc: F. Drake
R. Roettger
G. Vancill
R. Miller ✓

TAUM SAUK Inspection, Wed., May 13, 1970

Gage Comparisons.

<u>gage no.</u>	<u>4-9-70</u> <u>Last month</u>	<u>5-13-70</u> <u>This month</u>	<u>change</u>
1	11 $\frac{1}{2}$ "	12"	Down $\frac{1}{2}$ "
2	8 $\frac{1}{4}$ "	9"	Down $\frac{3}{4}$ "
3	13"	13 $\frac{1}{4}$ "	Down $\frac{1}{4}$ "
4	6 $\frac{1}{4}$ "	7"	Down $\frac{3}{8}$ "
5	28"	28 $\frac{1}{4}$ "	Down $\frac{1}{4}$ "
6	19"	19 $\frac{1}{2}$ "	Down $\frac{1}{2}$ "
7	16 $\frac{1}{4}$ "	16 $\frac{3}{4}$ "	Down $\frac{1}{2}$ "
8	15"	16 $\frac{1}{4}$ "	Down $1\frac{1}{4}$ "
9	-4"	-2 $\frac{3}{8}$ "	Down $1\frac{5}{8}$ "
10	20 $\frac{3}{4}$ "	21 $\frac{3}{4}$ "	Down 1"
11	15 $\frac{1}{4}$ "	16"	Down $\frac{3}{4}$ "
12	7 $\frac{3}{4}$ "	8 $\frac{1}{4}$ "	Down $\frac{1}{2}$ "
13	-2 $\frac{1}{2}$ "	-6 $\frac{3}{4}$ " same as 26 $\frac{1}{2}$ " on new gage	
14	14"		
15	28 $\frac{3}{4}$ "	30"	Down $1\frac{1}{4}$ "

computed leakage 4/9 - 5/14 is 13.13 up 1.91 cfs.

gage #13 was 4 $\frac{1}{2}$ "

gage #14 was being cleaned with back hoe not possible to get a good reading.

The gage readings are generally down while the computed leakage is up. The "fish pond" area, - say between panels 90 & 102, is up in leakage. The increase in leakage in the fish pond area represents from 2 to 3 cfs.

accompanied by FTD

RJM

REPORT OF INSPECTION
TAUM SAUK UPPER RESERVOIR

Date: Wed, May 13, 1970

RJM EFTD

Reservoir Elev: 1592 @ generating

Weather: fair & clear Surface water temp 64°F

Gage No.	Gage Height*	Condition of Gage	Comments
1	12"	OK	
2	9"	OK	
3	13 1/4"	OK	
4	7"	OK	
5	28 1/4"	OK	
6	19 1/2"	OK	Little rattle noise
7	16 3/4"	OK	
8	16 1/2"	OK	
9	-2 3/8"	OK	
10	21 3/4"	OK	
11	16"	OK	
12	8 1/4"	OK	
13	-6 3/8"		installed at gage 26 1/2" equivalent men removing slide near slide channel discharge
14			
15	30"		
16			
17			

* Amount of gage above water surface

General Comments: Leakage was generally down except for area between panels 28 & 102 where it has increased. Drainage channel below panel 30 should be opened to allow water passage to relieve head on sink hole.

*TAMM SHARK UPPER RESEARCH
Location of Looking Flow Gages*

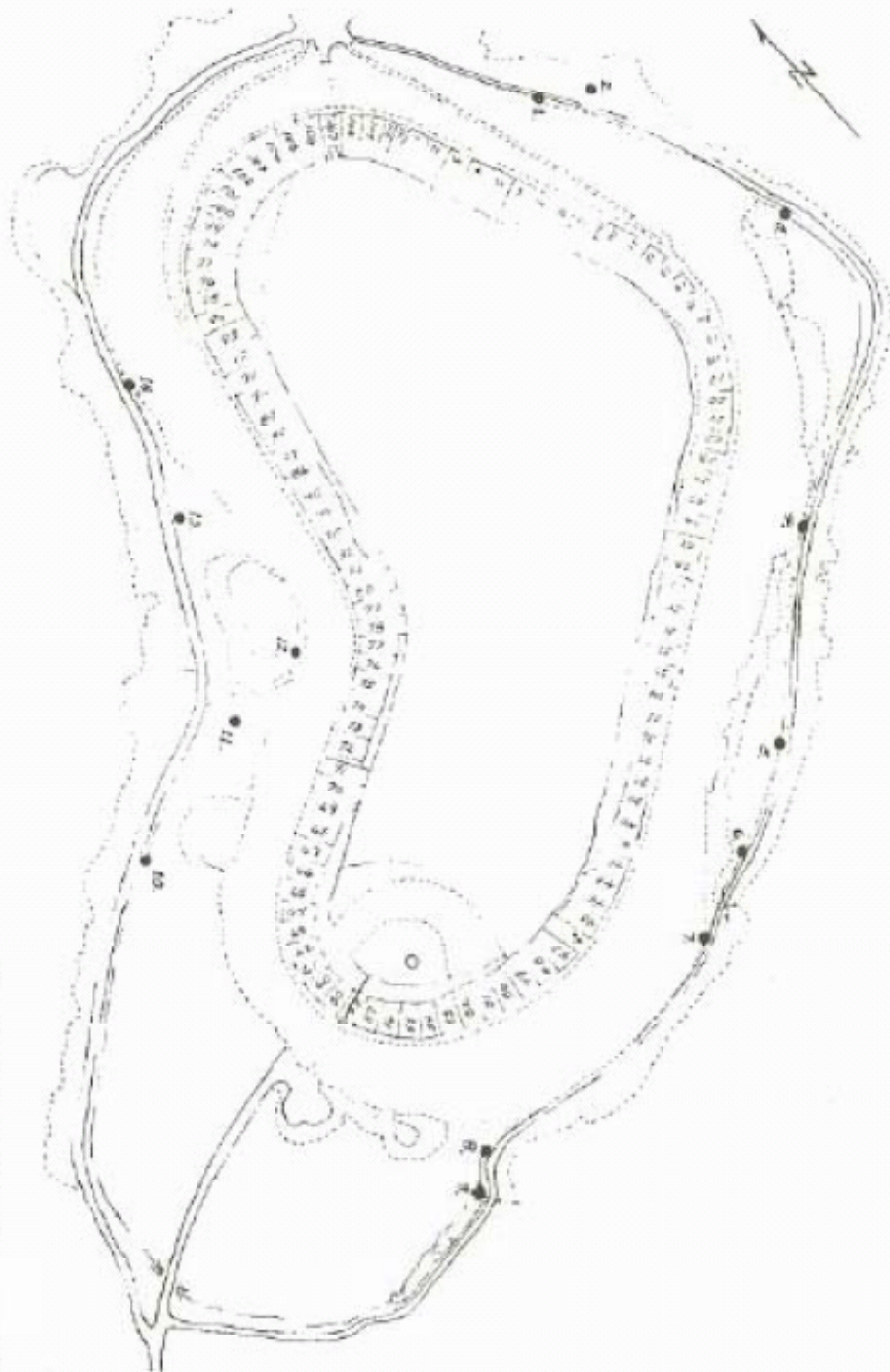

IMG054641

Appendix D

Figures



Taum Sauk – Upper Reservoir Full
Figure 1-1

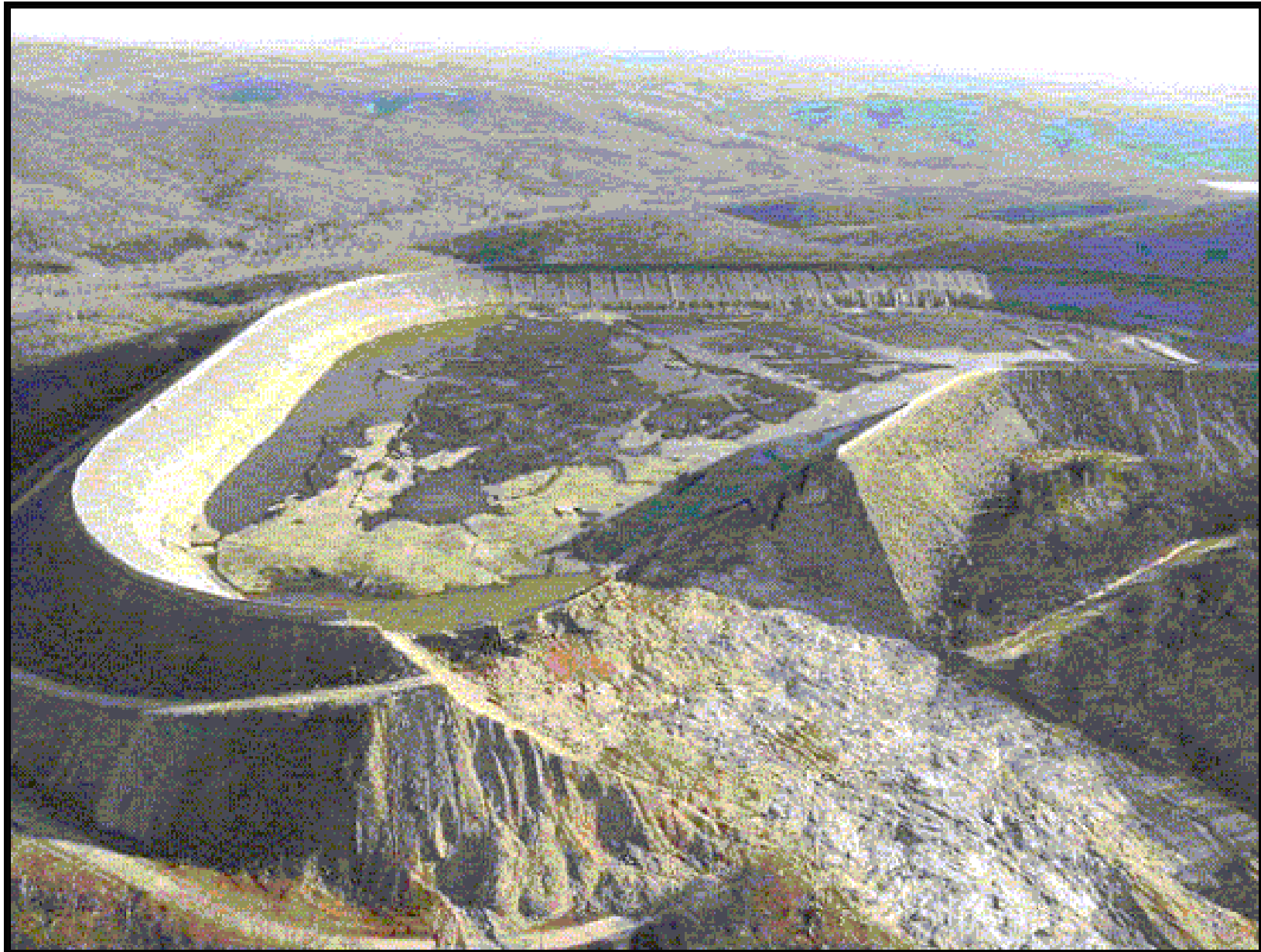

Taum Sauk Upper Reservoir Breached

Figure 1-2



Taum Sauk Reservoir

14 December 2005 Dam Rupture - Lesterville, MO

UNCLASSIFIED
//For Official Use Only

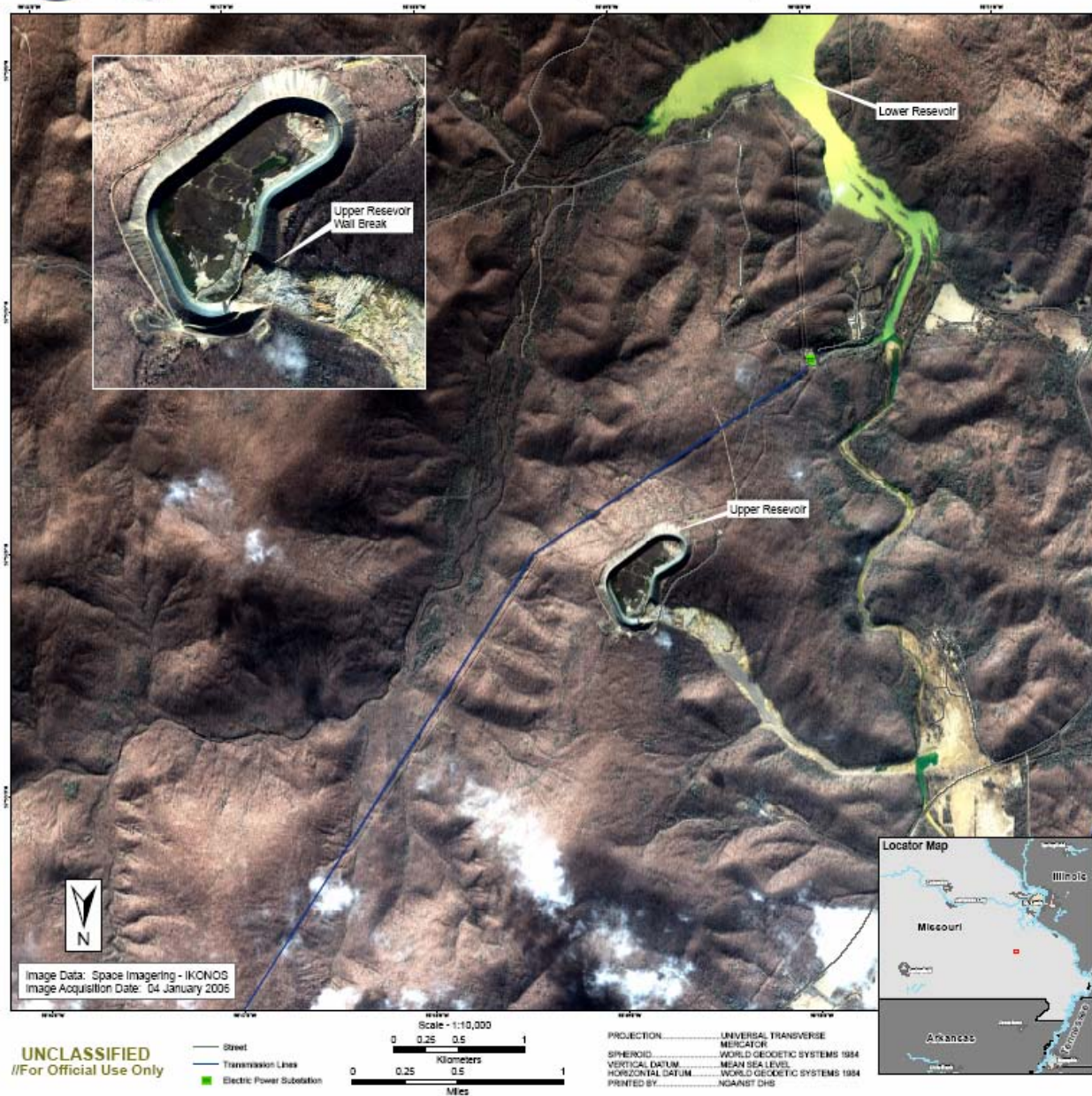

Figure 1-3

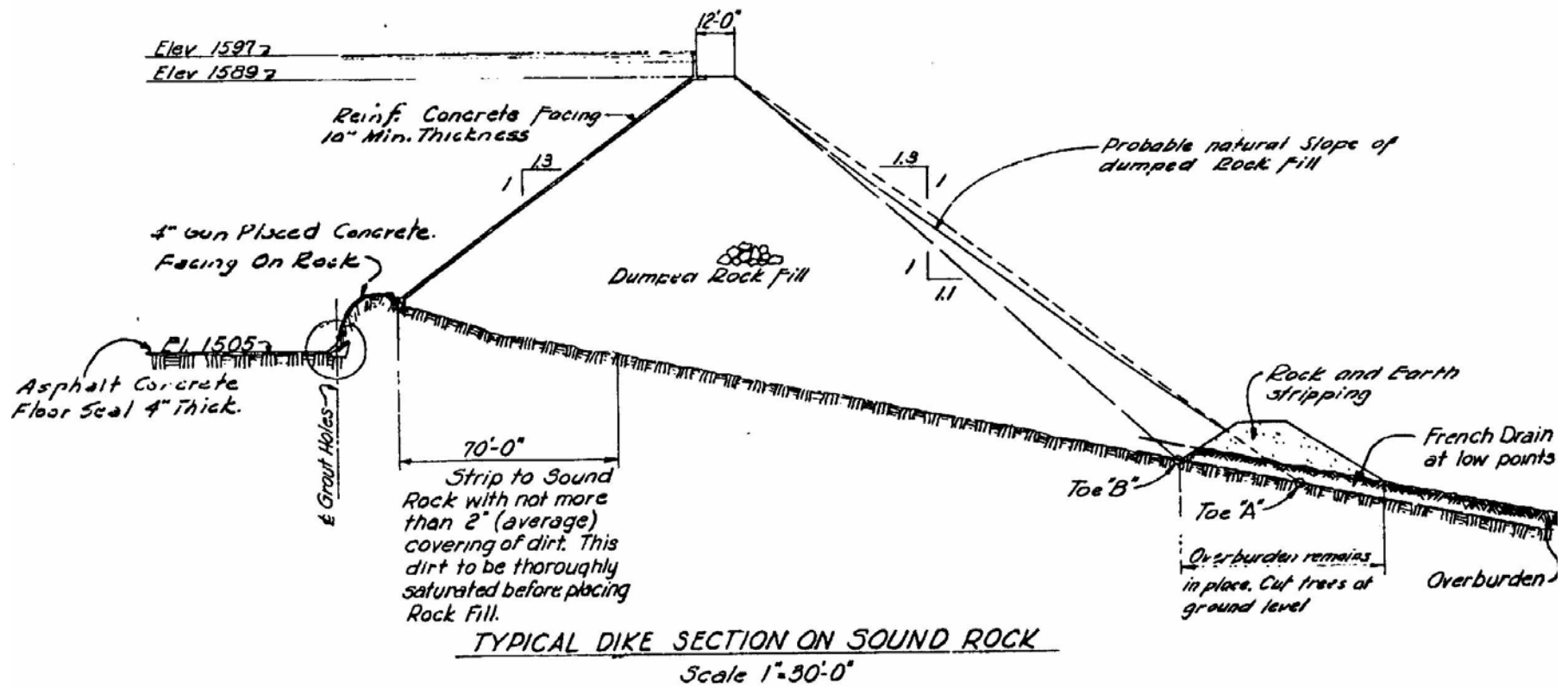
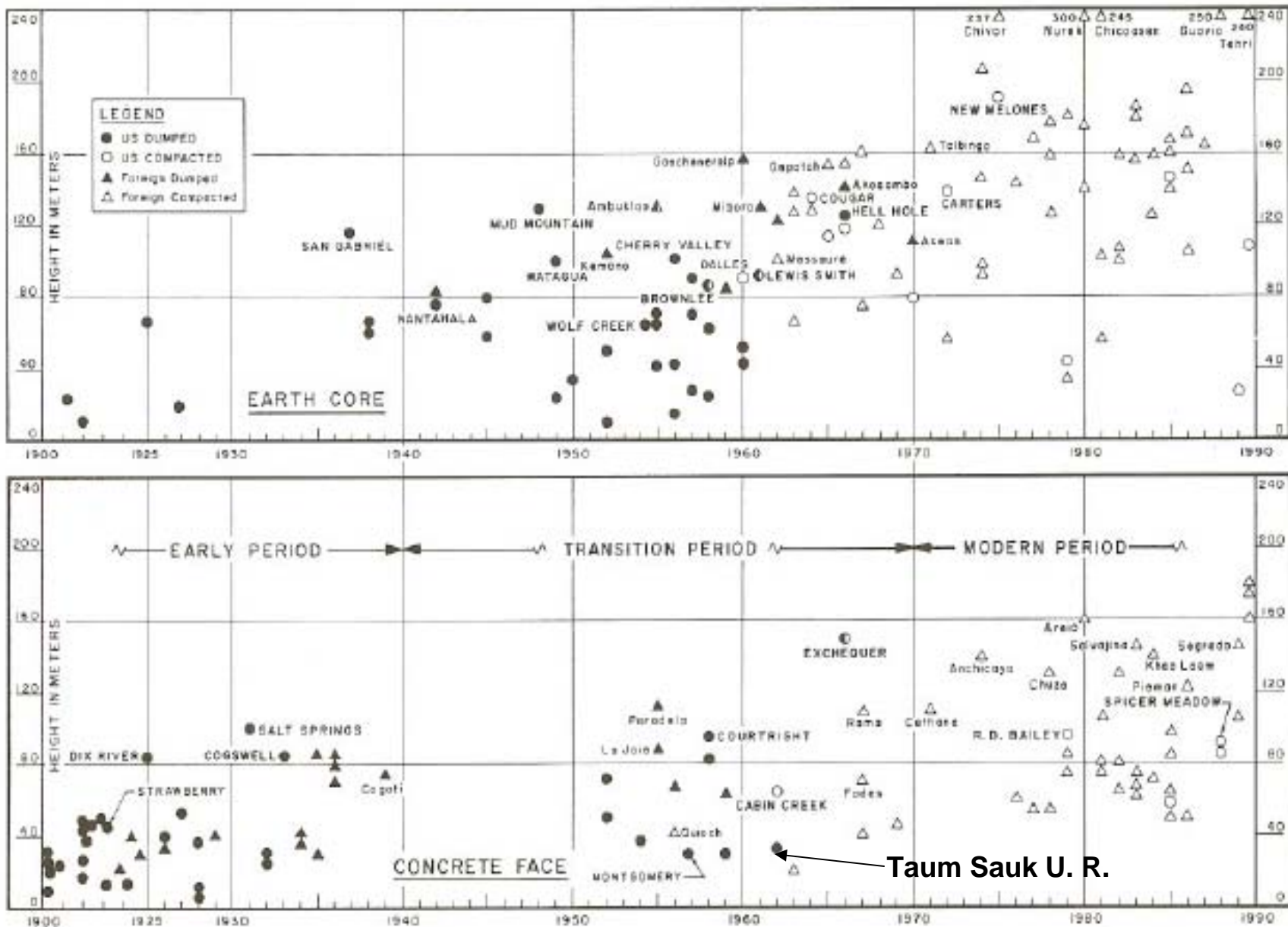
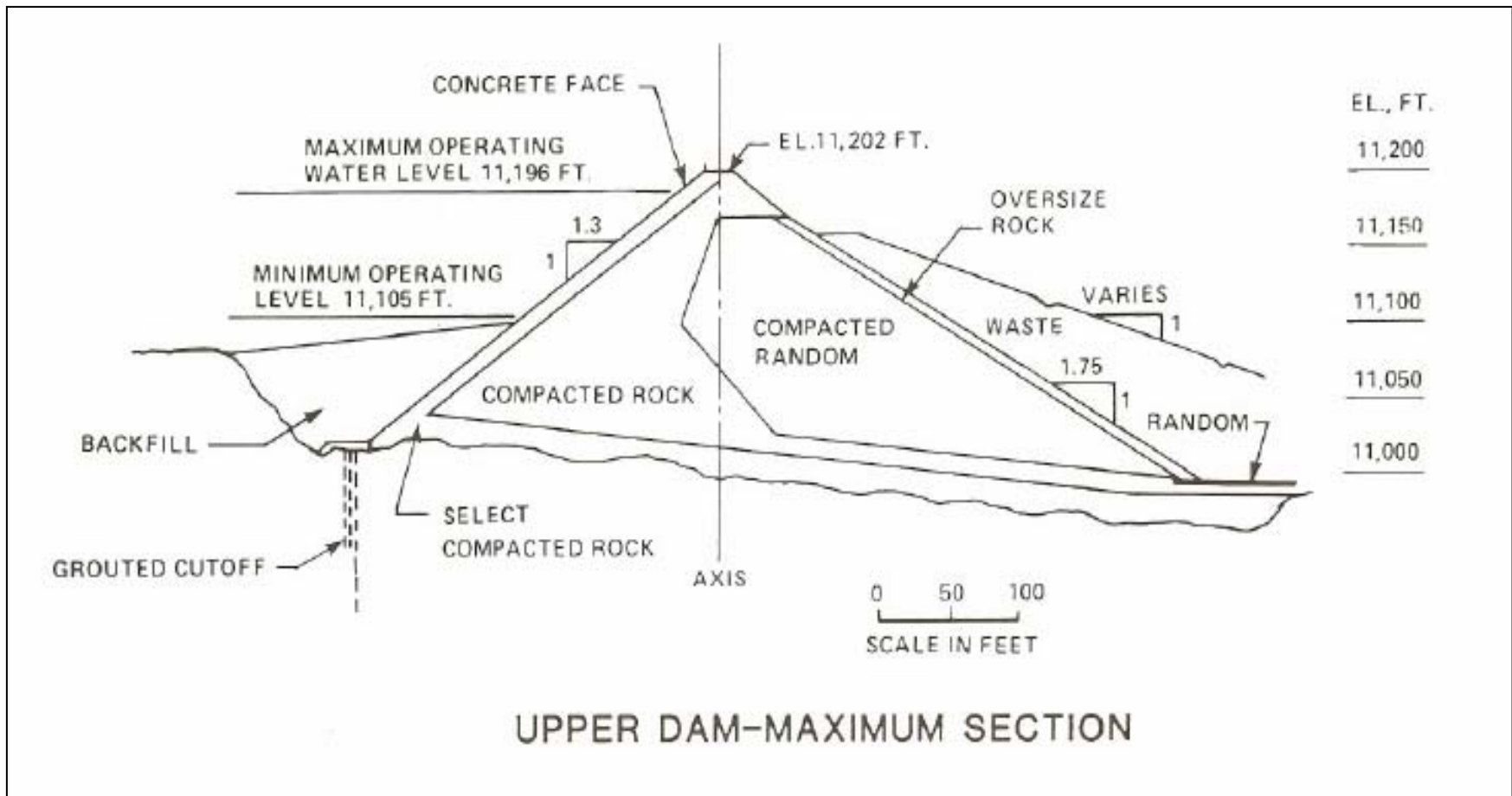

Figure 2-1 Cross section from original design drawings



Trends in Type and Height of Rockfill Dams

Figure 3-1



Cabin Creek Upper Reservoir Embankment

Figure 3-2

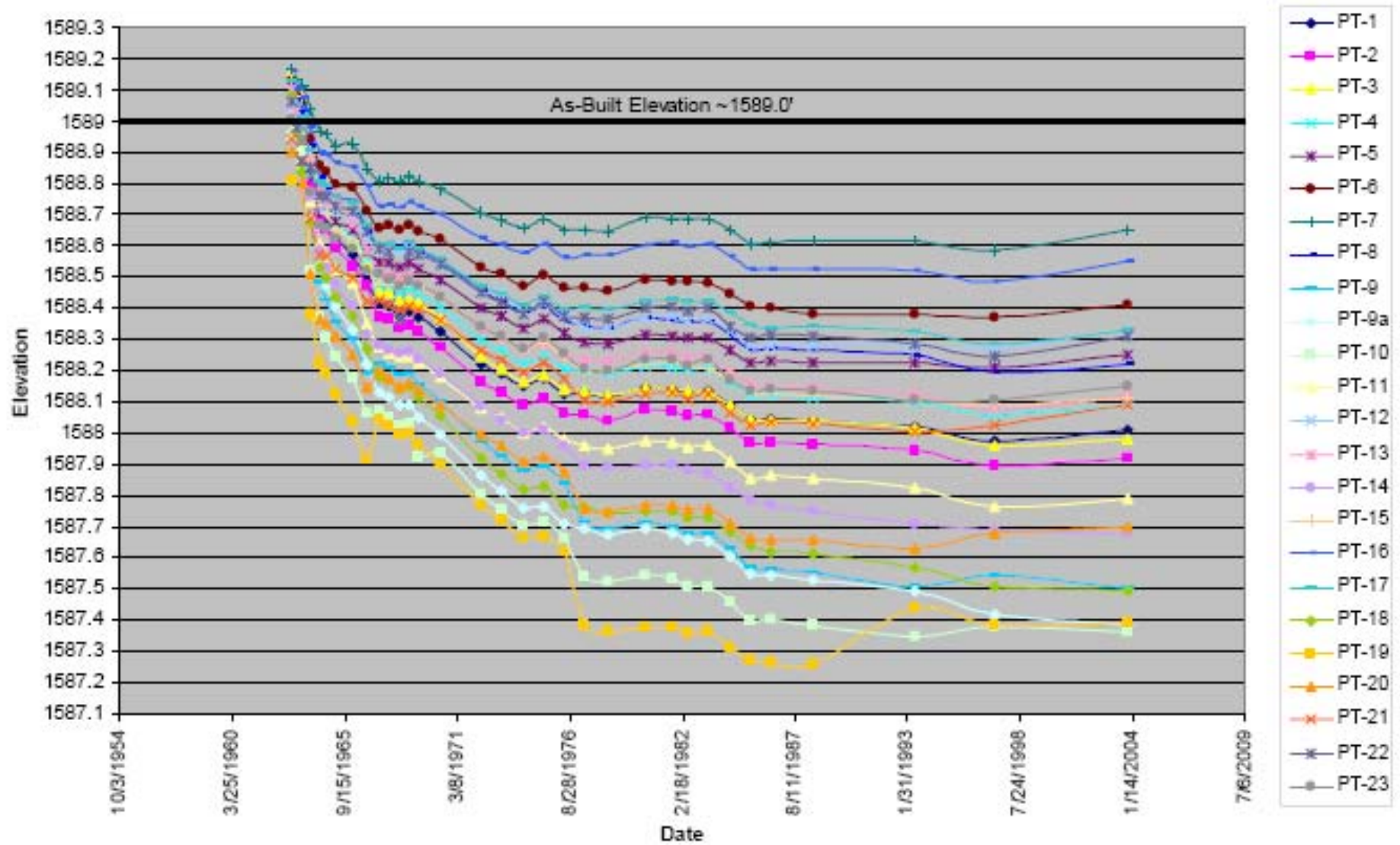

Total Settlement History
Upper Reservoir Pin Elevations

Figure 3-3

TAUM SAUK UPPER RESERVOIR MONUMENT SURVEY DATA

STATION	8/22/1987	8/28/1988	5/29/1993	5/11/1997	11/18/1998	11/18/1998	11/18/1998	11/18/1998	11/18/1998	11/18/1998	11/18/1998	11/18/1998	11/18/1998
1	1507.847	1508.011	1508.021	1507.914	1508.019	1508.019	1508.019	1508.019	1508.019	1508.019	1508.019	1508.019	1508.019
2	1507.869	1507.862	1507.884	1507.883	1507.883	1507.883	1507.883	1507.883	1507.883	1507.883	1507.883	1507.883	1507.883
3	1508.045	1508.040	1508.014	1507.971	1508.000	1508.000	1508.000	1508.000	1508.000	1508.000	1508.000	1508.000	1508.000
4	1508.148	1508.117	1508.024	1508.021	1508.000	1508.000	1508.000	1508.000	1508.000	1508.000	1508.000	1508.000	1508.000
5	1508.217	1508.210	1508.245	1508.245	1508.211	1508.210	1508.210	1508.210	1508.210	1508.210	1508.210	1508.210	1508.210
6	1508.409	1508.415	1508.409	1508.409	1508.315	1508.419	1508.419	1508.419	1508.419	1508.419	1508.419	1508.419	1508.419
7	1508.610	1508.616	1508.616	1508.600	1508.600	1508.600	1508.600	1508.600	1508.600	1508.600	1508.600	1508.600	1508.600
8	1508.367	1508.365	1508.349	1508.349	1508.349	1508.329	1508.329	1508.329	1508.329	1508.329	1508.329	1508.329	1508.329
9	1507.610	1507.600	1507.616	1507.616	1507.616	1507.616	1507.616	1507.616	1507.616	1507.616	1507.616	1507.616	1507.616
10	1507.540	1507.529	1507.490	1507.417	1507.380	1507.380	1507.380	1507.380	1507.380	1507.380	1507.380	1507.380	1507.380
11	1507.467	1507.464	1507.447	1507.426	1507.380	1507.380	1507.380	1507.380	1507.380	1507.380	1507.380	1507.380	1507.380
12	1507.884	1507.882	1507.824	1507.781	1507.780	1507.780	1507.780	1507.780	1507.780	1507.780	1507.780	1507.780	1507.780
13	1508.223	1508.217	1508.217	1508.217	1508.217	1508.217	1508.217	1508.217	1508.217	1508.217	1508.217	1508.217	1508.217
14	1508.462	1508.462	1508.427	1508.373	1508.329	1508.329	1508.329	1508.329	1508.329	1508.329	1508.329	1508.329	1508.329
15	1507.809	1507.800	1507.798	1507.887	1507.880	1507.880	1507.880	1507.880	1507.880	1507.880	1507.880	1507.880	1507.880
16	1508.143	1508.149	1508.135	1508.080	1508.135	1508.135	1508.135	1508.135	1508.135	1508.135	1508.135	1508.135	1508.135
17	1508.524	1508.527	1508.519	1508.486	1508.520	1508.520	1508.520	1508.520	1508.520	1508.520	1508.520	1508.520	1508.520
18	1508.330	1508.342	1508.328	1508.287	1508.330	1508.330	1508.330	1508.330	1508.330	1508.330	1508.330	1508.330	1508.330
19	1507.814	1507.810	1507.800	1507.800	1507.800	1507.800	1507.800	1507.800	1507.800	1507.800	1507.800	1507.800	1507.800
20	1507.480	1507.489	1507.439	1507.482	1507.480	1507.480	1507.480	1507.480	1507.480	1507.480	1507.480	1507.480	1507.480
21	1507.711	1507.717	1507.717	1507.680	1507.700	1507.700	1507.700	1507.700	1507.700	1507.700	1507.700	1507.700	1507.700
22	1508.048	1508.039	1508.020	1508.025	1508.020	1508.020	1508.020	1508.020	1508.020	1508.020	1508.020	1508.020	1508.020
23	1508.217	1508.217	1508.205	1508.245	1508.215	1508.215	1508.215	1508.215	1508.215	1508.215	1508.215	1508.215	1508.215
24	1508.089	1508.089	1508.150	1508.027	1508.150	1508.150	1508.150	1508.150	1508.150	1508.150	1508.150	1508.150	1508.150

NOTES:

- DATA FOR SURVEY SURVEY WAS CALCULATED FROM SETBACK DATA (STANDARD) DERIVED FROM PLAN.
- HORIZONTAL DATA COMMENCED IN 2001.
- DATE OF DATA: DATA SHOWN ON THIS TABLE IS FROM RECORDS PROVIDED BY OWNER. EXCEPT FOR THE DATA COLLECTED 11-18-83 AND 12-20-83 WHICH IS ACTUAL FIELD DATA COLLECTED BY SURVEY GROUP SURVEY CREW.
- SEE PLAN: TOP OF CORNER BOLT SET IN TOP OF CONCRETE GRASS FINISH (GRADE AND YELLOW 2 1/2" NORTH FROM CENTERLINE OF GATE AT BASE OF NORTH BARR).
- HORIZONTAL SURVEY DATA BASED ON 1983 STATE PLANE COORDINATE SYSTEM.

ELEVATION = 1985 ME (LOWWATER)
 MONUMENT = 42001100
 DATUM = 1985.03.21

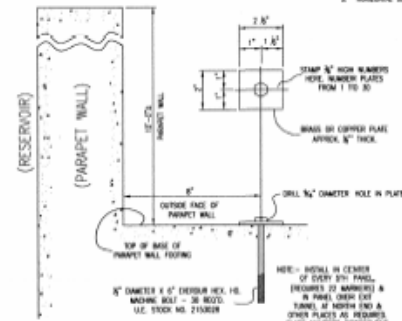
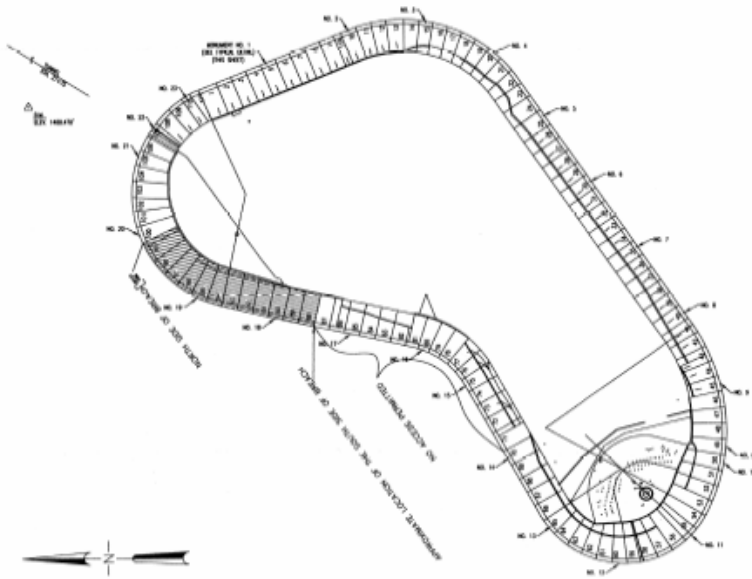

TYPICAL DETAIL
 MONUMENT AT PARAPET
 WALL
 SCALE: NOT TO SCALE

SCALE: 1" = 200'

NO.	DATE	BY/CHKD
1	12/22/00	DETAILED SCALE
2	12/22/00	AMERICAN SURVEYING AND MAPPING, INC.

KdG

PROJECT NO. _____ CONTRACT NO. _____
 DRAWN BY _____ DATE _____
 CHECKED BY _____
 DATE _____

S2

68 Progress Parkway
 Maryland Heights,
 Missouri 63043-2748
 (314) 621-8888

MO666626

Figure 3-4
 (See Large Drawing S2 Provided)

Source: J. Barry Cooke & Arthur Strassburger, "1998 Review of Safety Report (Seventh Five-Year Report), Inspection of Project Works, Taum Sauk Project," March 1998

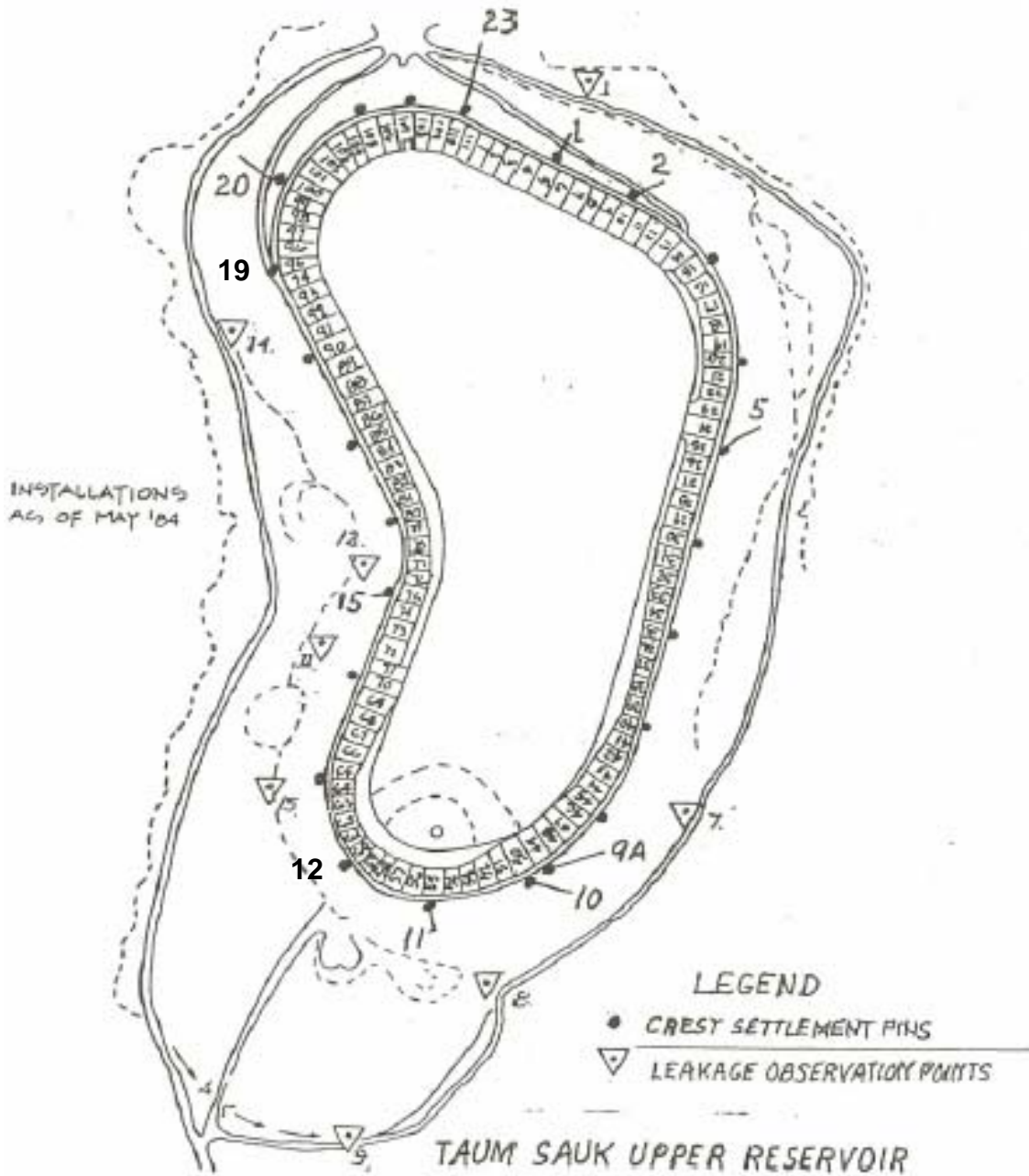

REV. 1/98

Figure 5-1. Upper Dam Settlement Monuments and Weir Locations

Figure 3-4A

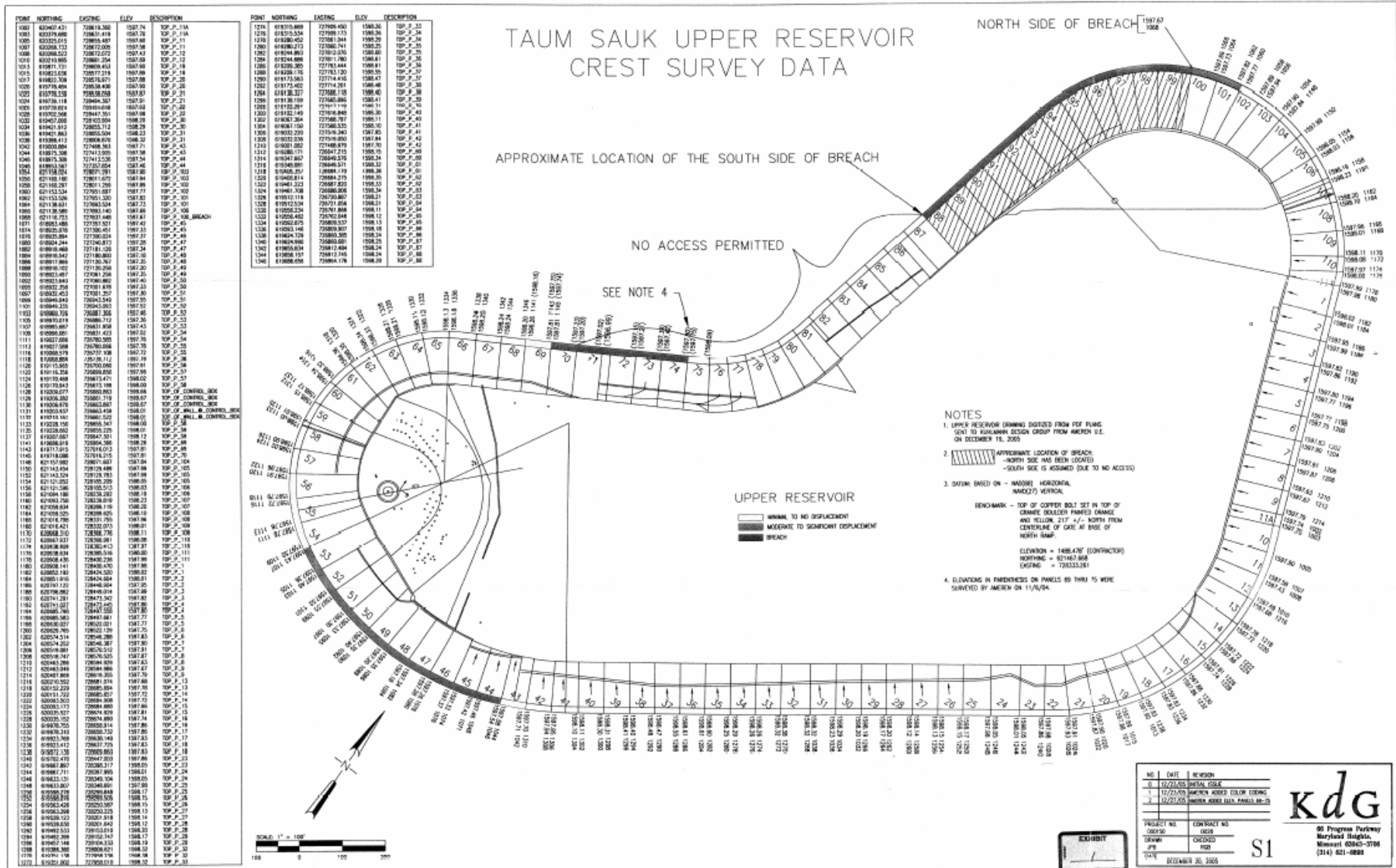
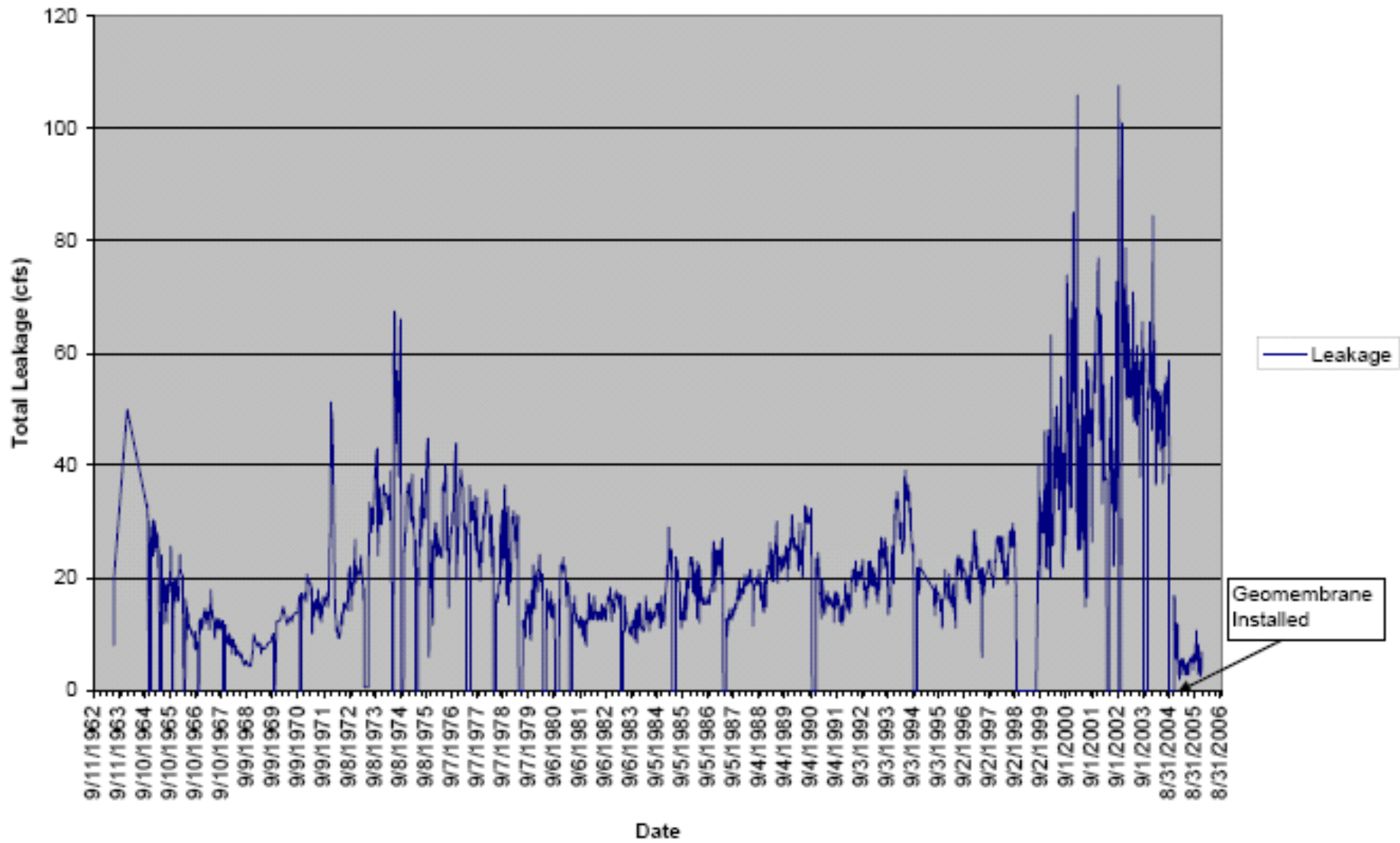

Figure 3-5
(See Large Drawing S1 Provided)



Total Leakage (cfs) vs Time

Figure 3-6

Taum Sauk Pump Shutdown Logic As-Designed, 11/01/2004

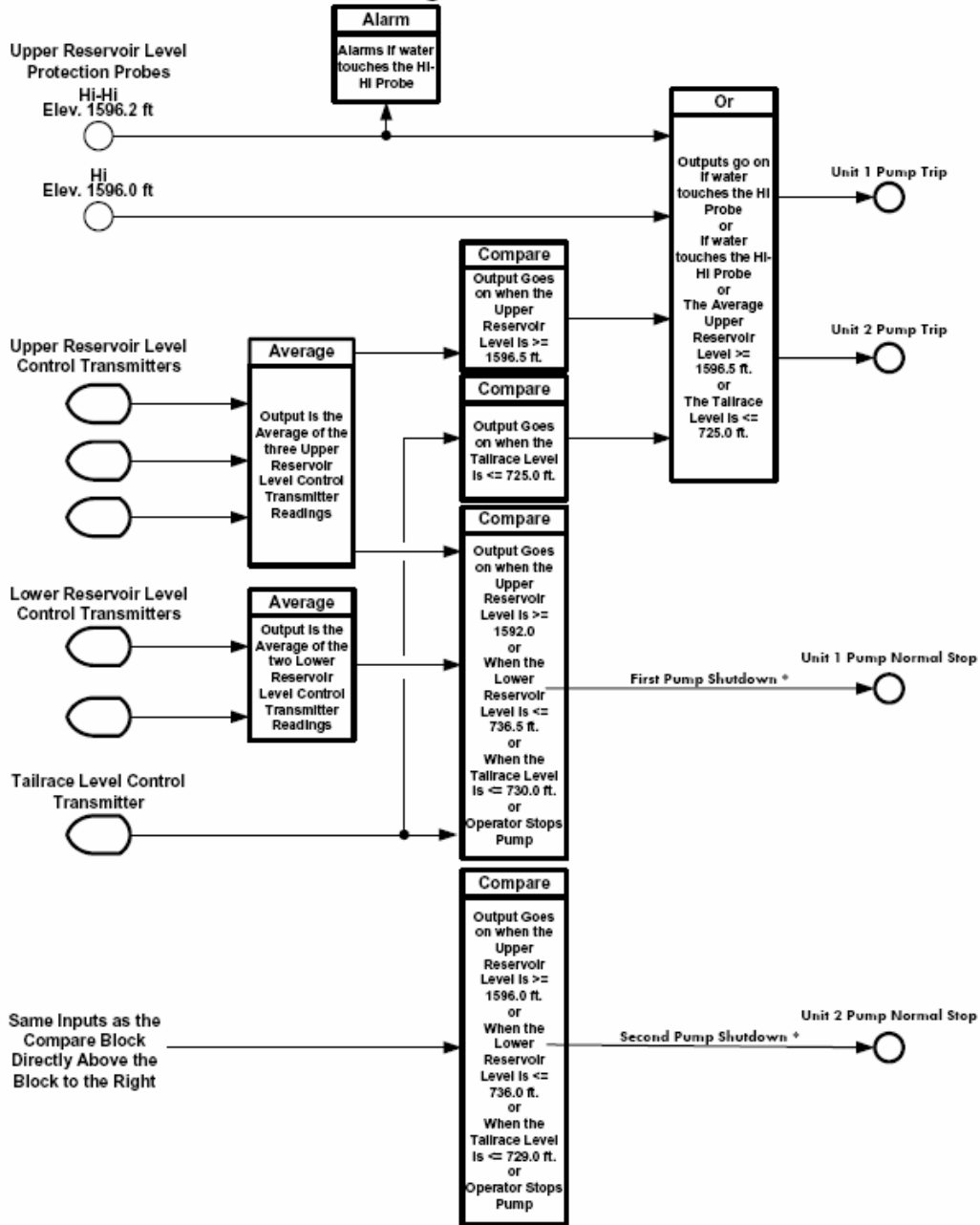

* Pump shutdown order is operator selectable.

Figure 5-1

Taum Sauk Pump Shutdown Logic 12/01/2004

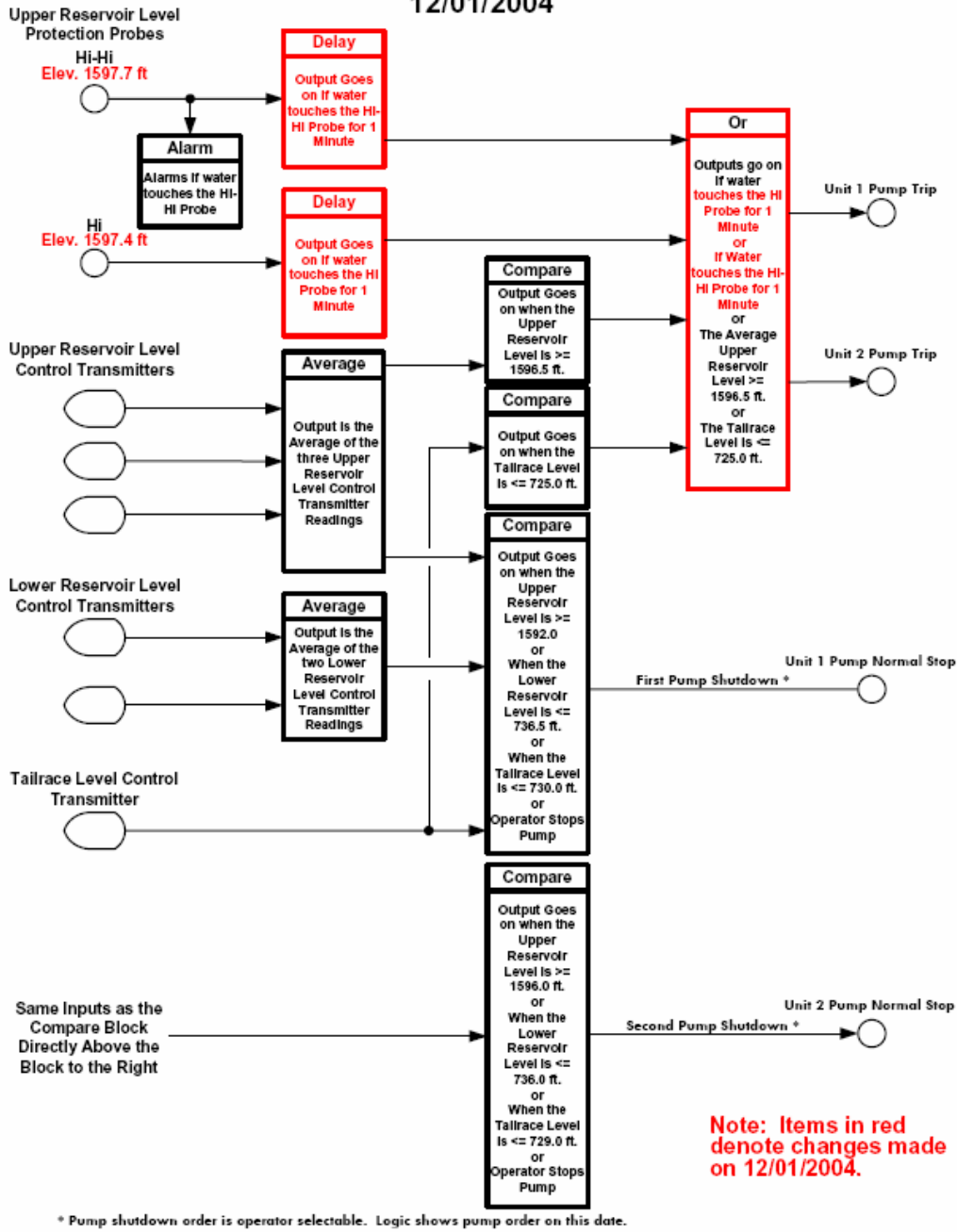
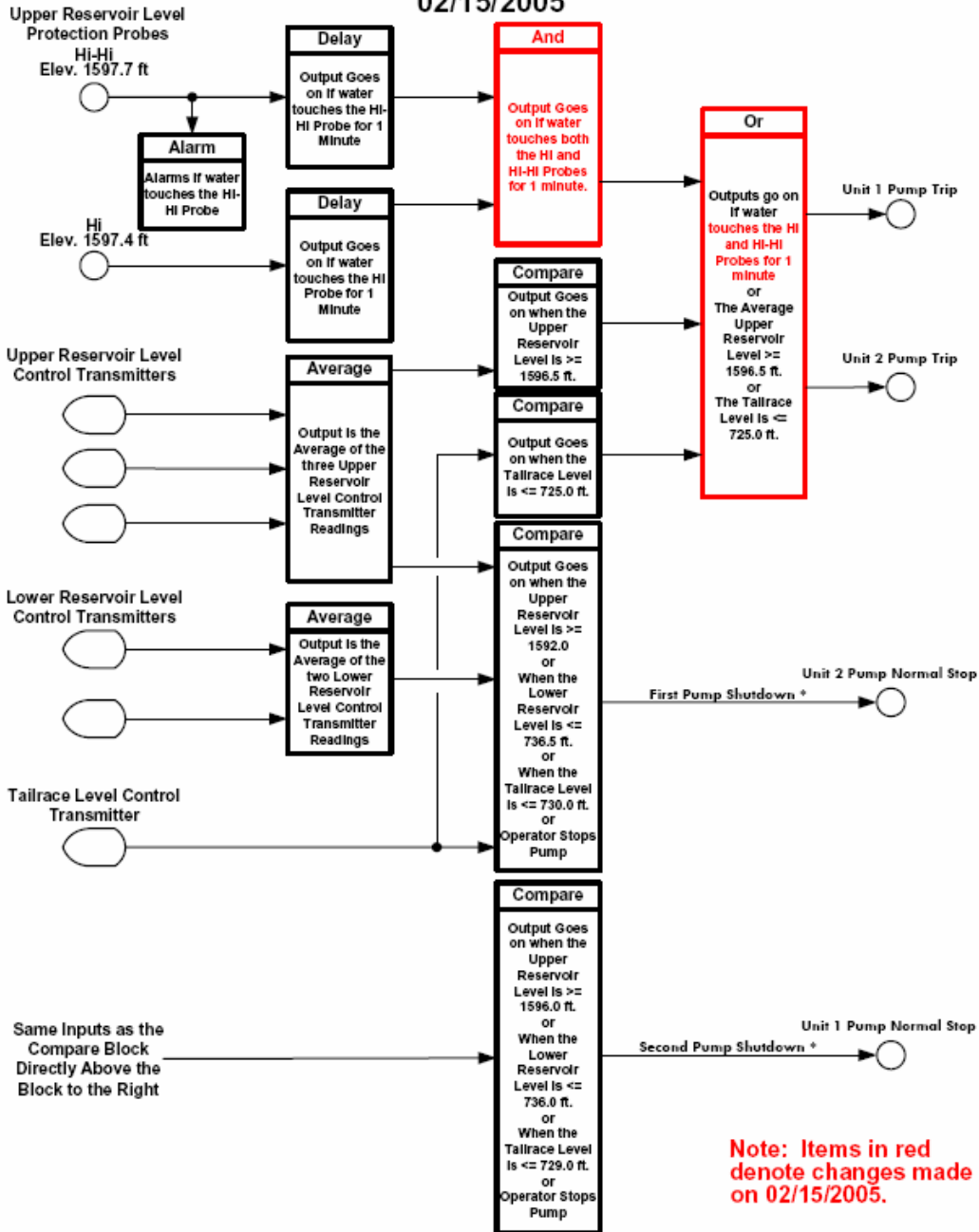

Figure 5-2

Taum Sauk Pump Shutdown Logic

02/15/2005



Note: Items in red denote changes made on 02/15/2005.

* Pump shutdown order is operator selectable. Logic shows pump order on this date.

Figure 5-3



Taum Sauk
Upper Reservoir
Breach 12/14/05

Figure 6-1

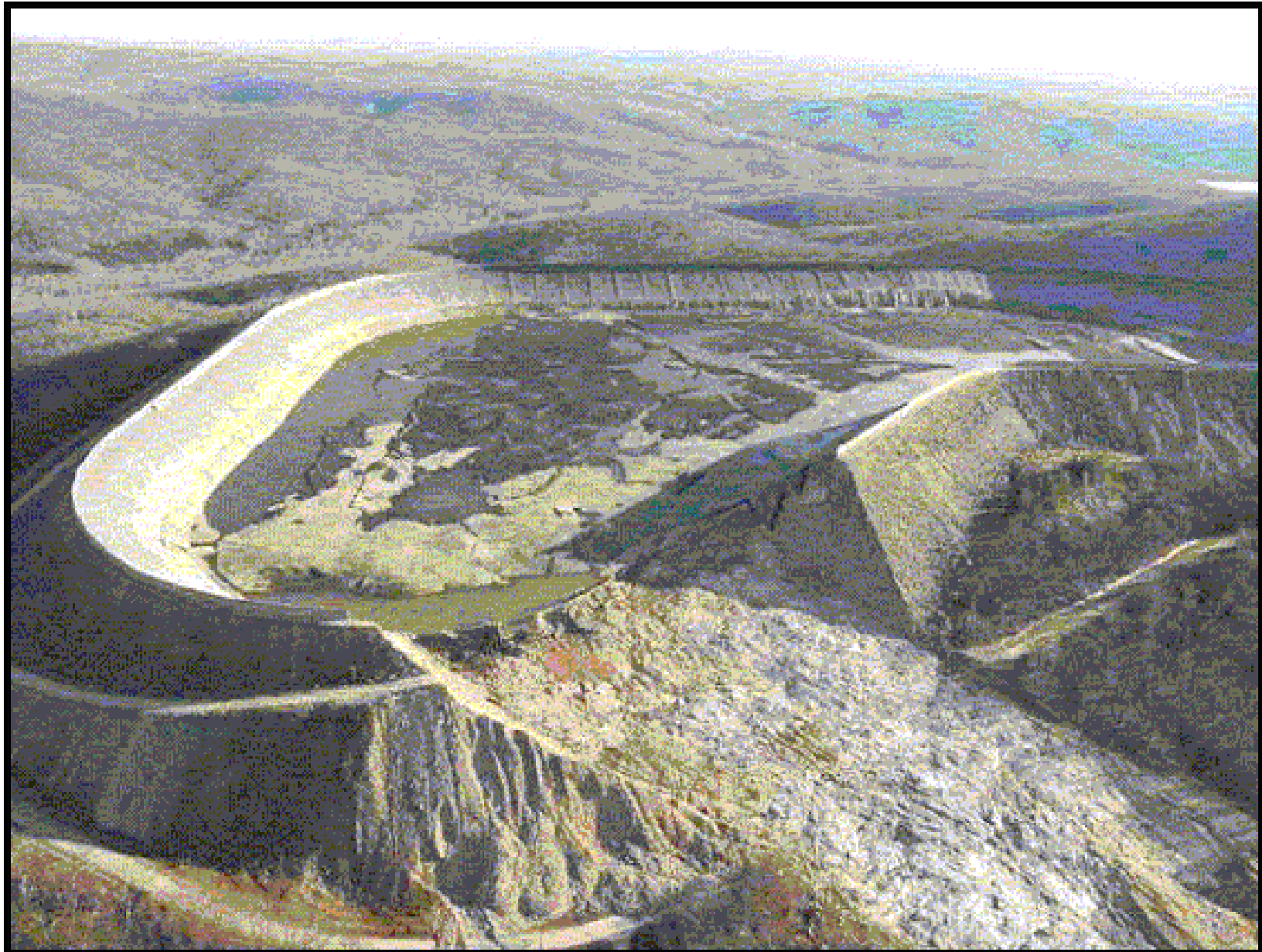
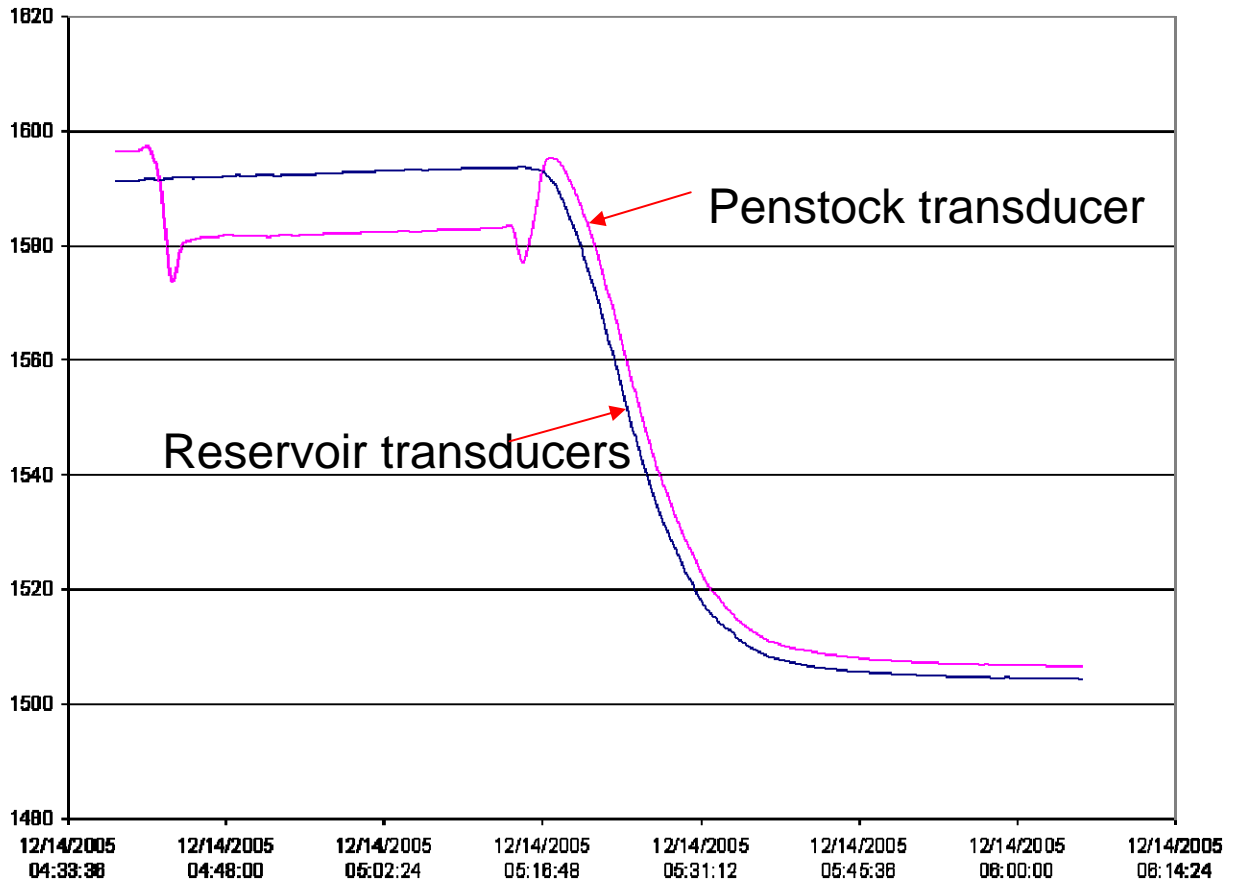

Figure 6-2



Dec. 14th breach.

Figure 6-3

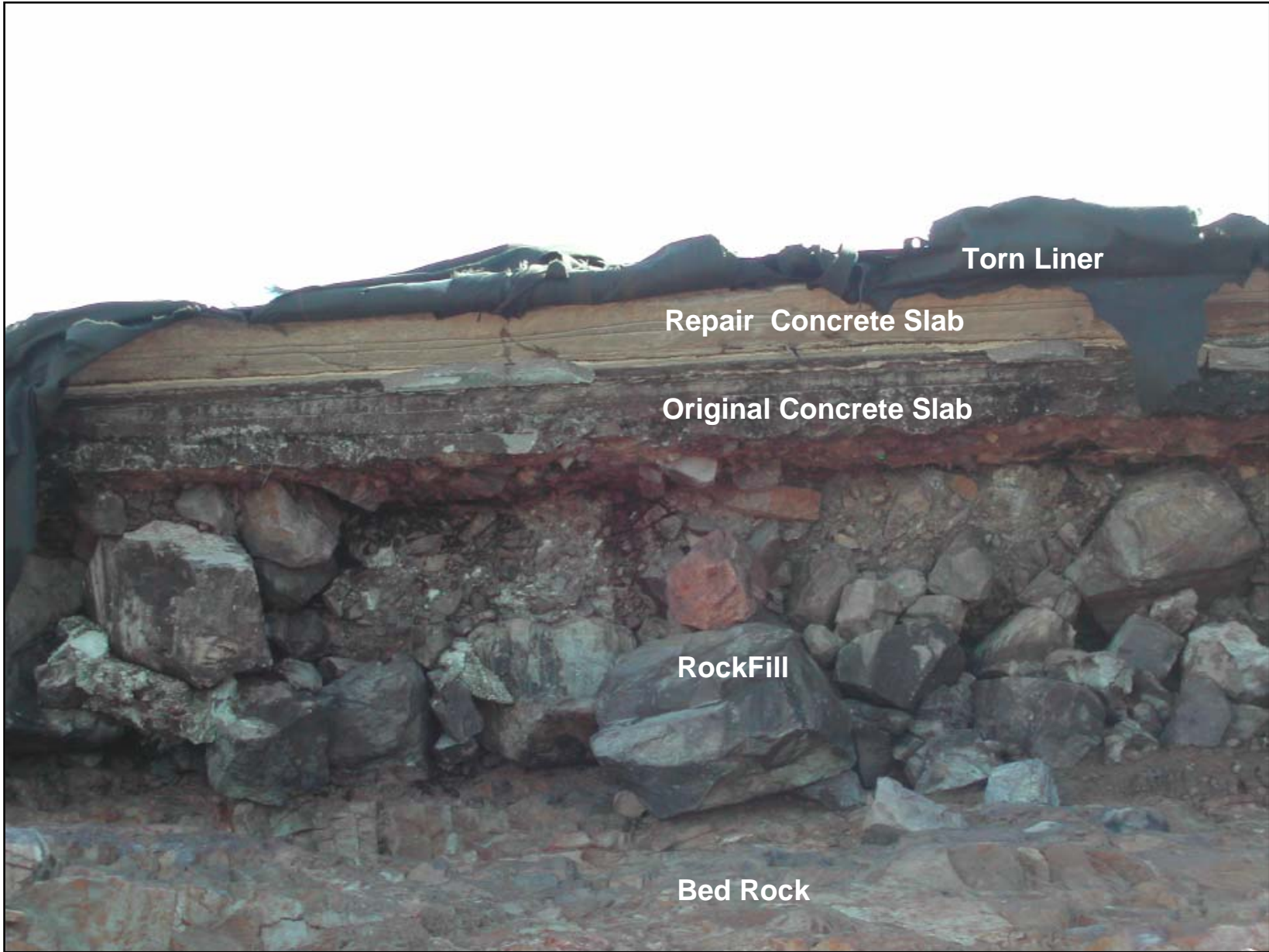

Figure 6-4



Eroded foundation, note rock jointing and overlying clay materials

Figure 6-5



Rockfill between top of rock and base of plinth

Figure 6-6



Rockfill between top of rock and base of plinth,
note reddish grout in rockfill beneath the plinth

Figure 6-7



Rockfill between top
of rock and base of plinth

Figure 6-8

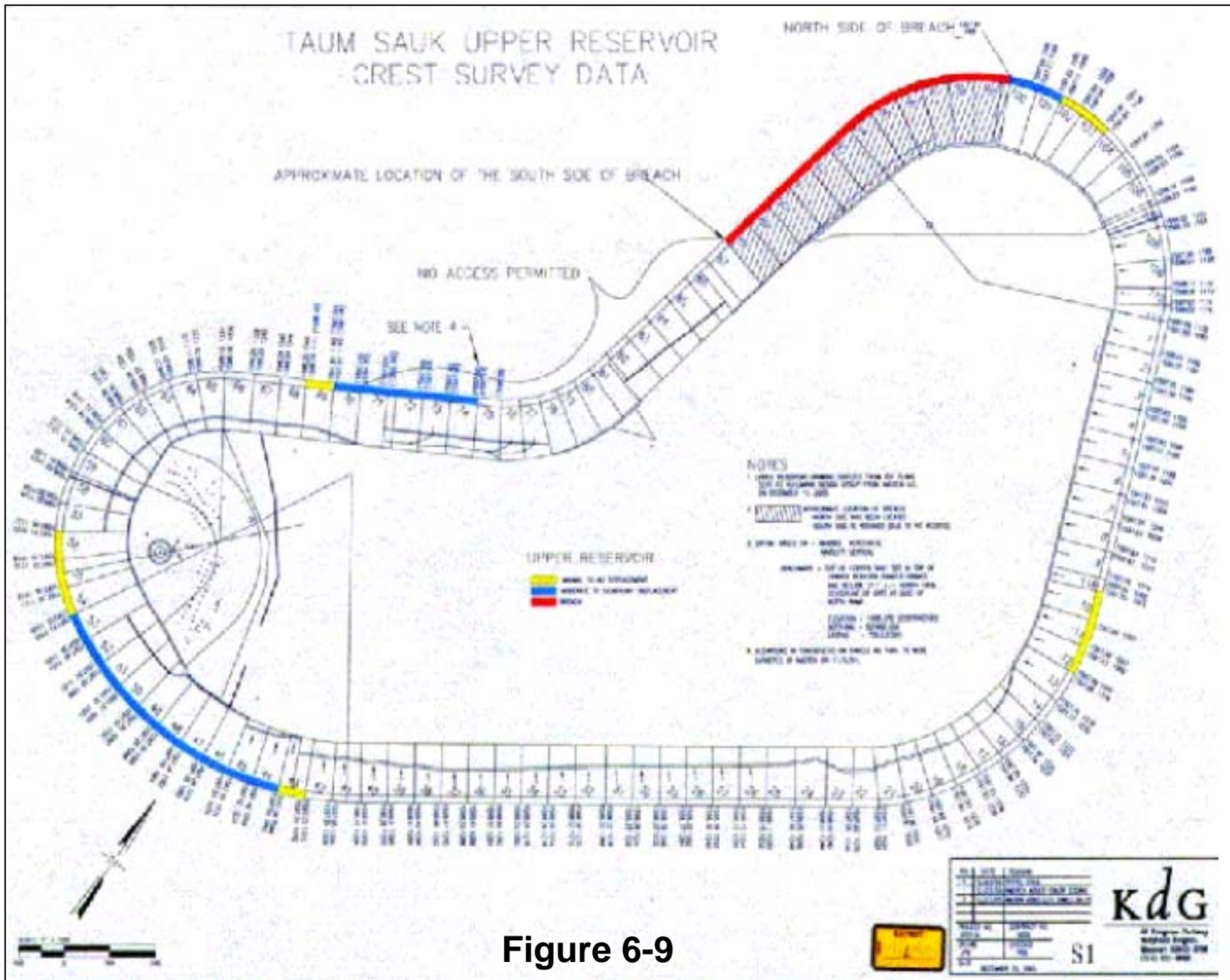

Figure 6-9

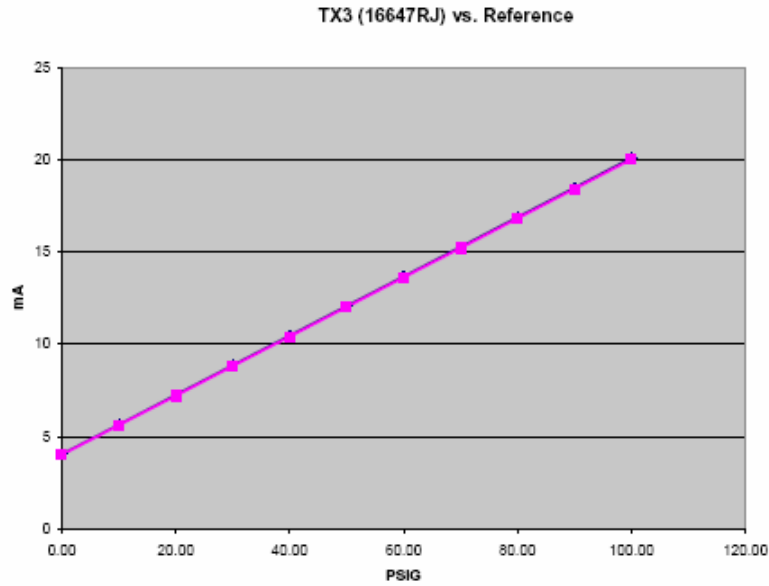

Figure 18: TX3 (16647RJ) vs. Reference

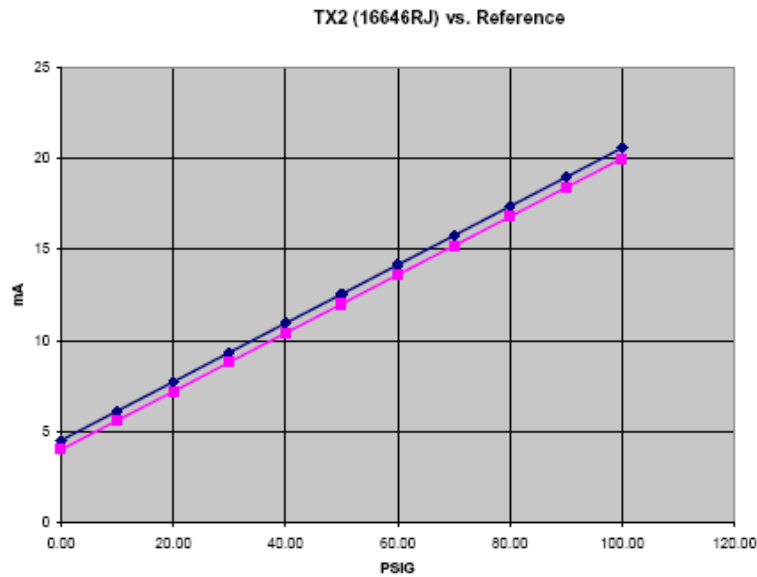

Figure 17: TX2 (16646RJ) vs. Reference

Pressure Transducers TX2 and TX3 Compared to Reference Transducer (TX2 reads average of 7.86 feet high and TX3 reads average of 0.85 feet high)

Figure 7-1

TX2 (16646RJ) at 40 PSIG

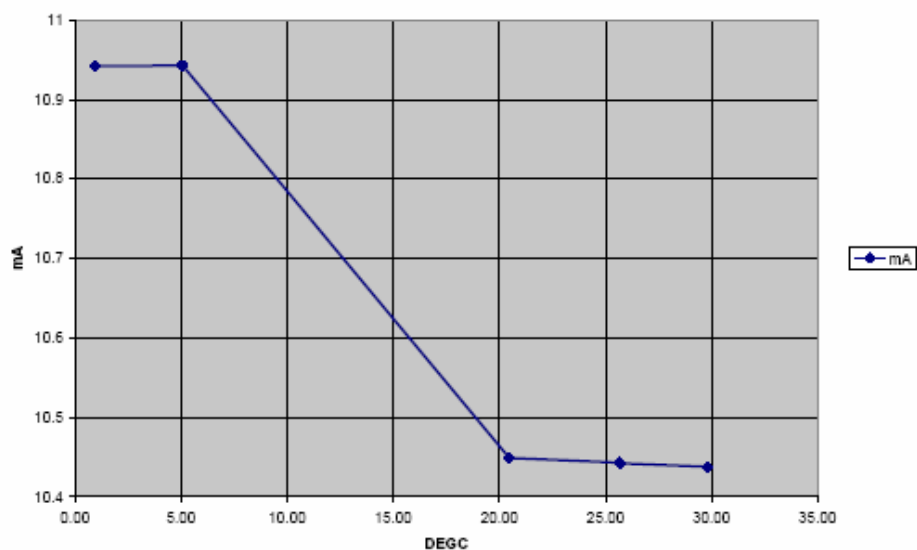

Figure 19: Temperature Sensitivity of TX2

TX3 (16647RJ) at 40 PSIG

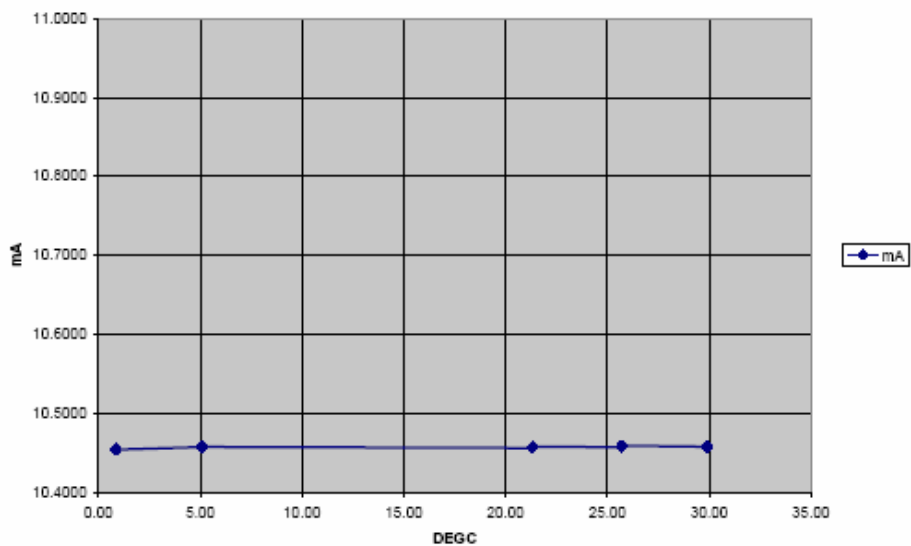
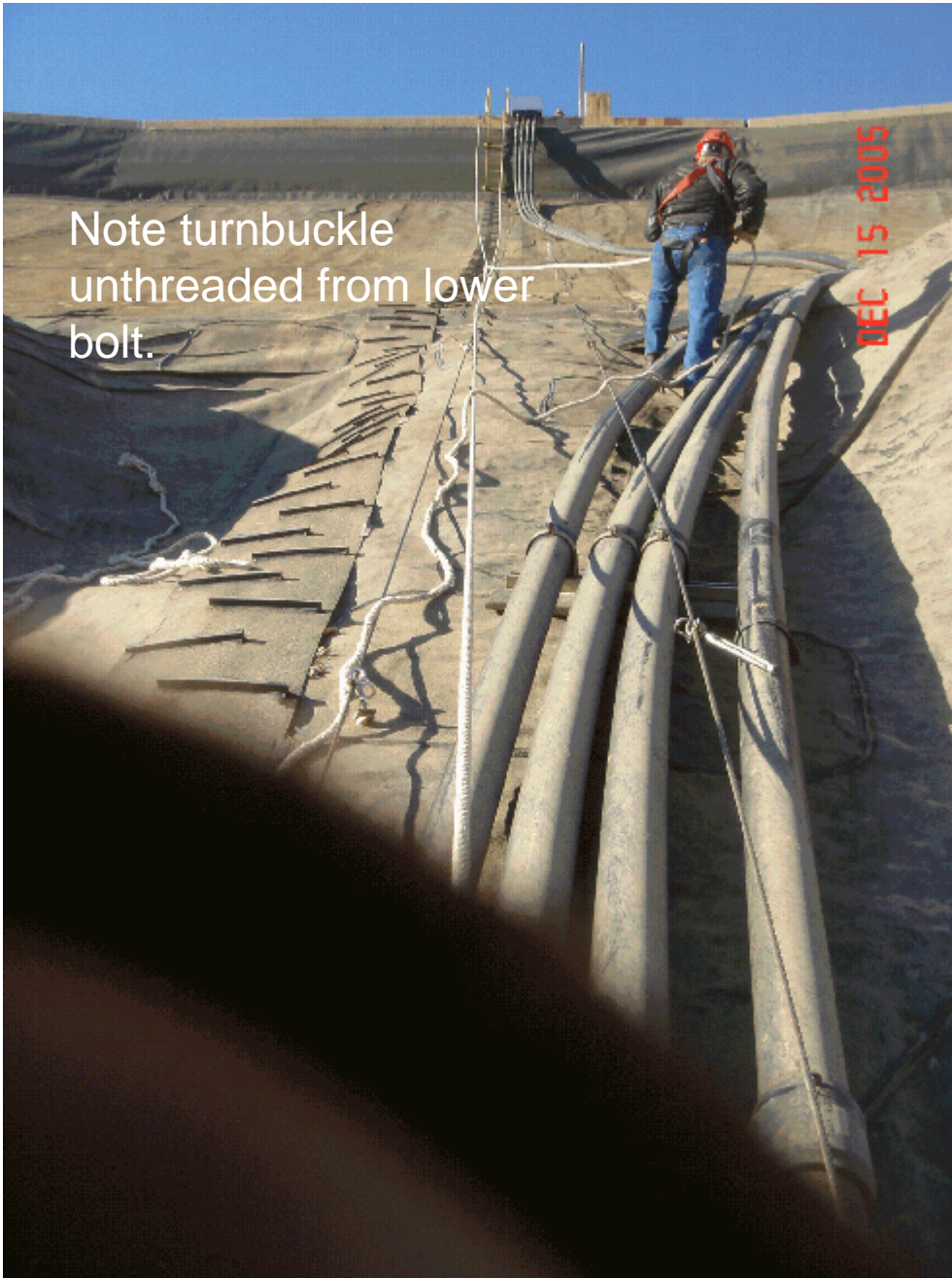

Figure 20: Temperature Sensitivity of TX3

**Pressure Transducer Temperature Sensitivity
(TX2 Output Shift Represents +7.11 Ft. of Water Level
at 5 degrees compared to 20 degrees)**

Figure 7-2



Note turnbuckle
unthreaded from lower
bolt.

Figure 7-3



Figure 7-4



Note, straightening of protective pipes between dates of above photos.

Figure 7-5



**Upper ends of protective pipes
with instrument cables in enclosure on parapet.
Pressure transducers use left pipe
and conductivity probes use the second pipe from left.**

Figure 7-6



Protective pipe base plates are not anchored to reservoir.
Left guy cable has come loose from base plate in top photo.

Figure 7-7



Protective pipe support system as found. Note eye bolt unthreaded from turnbuckle. Also note lock washer in place at connection to U channel but lack of lock washer at turnbuckle.

Figure 7-8

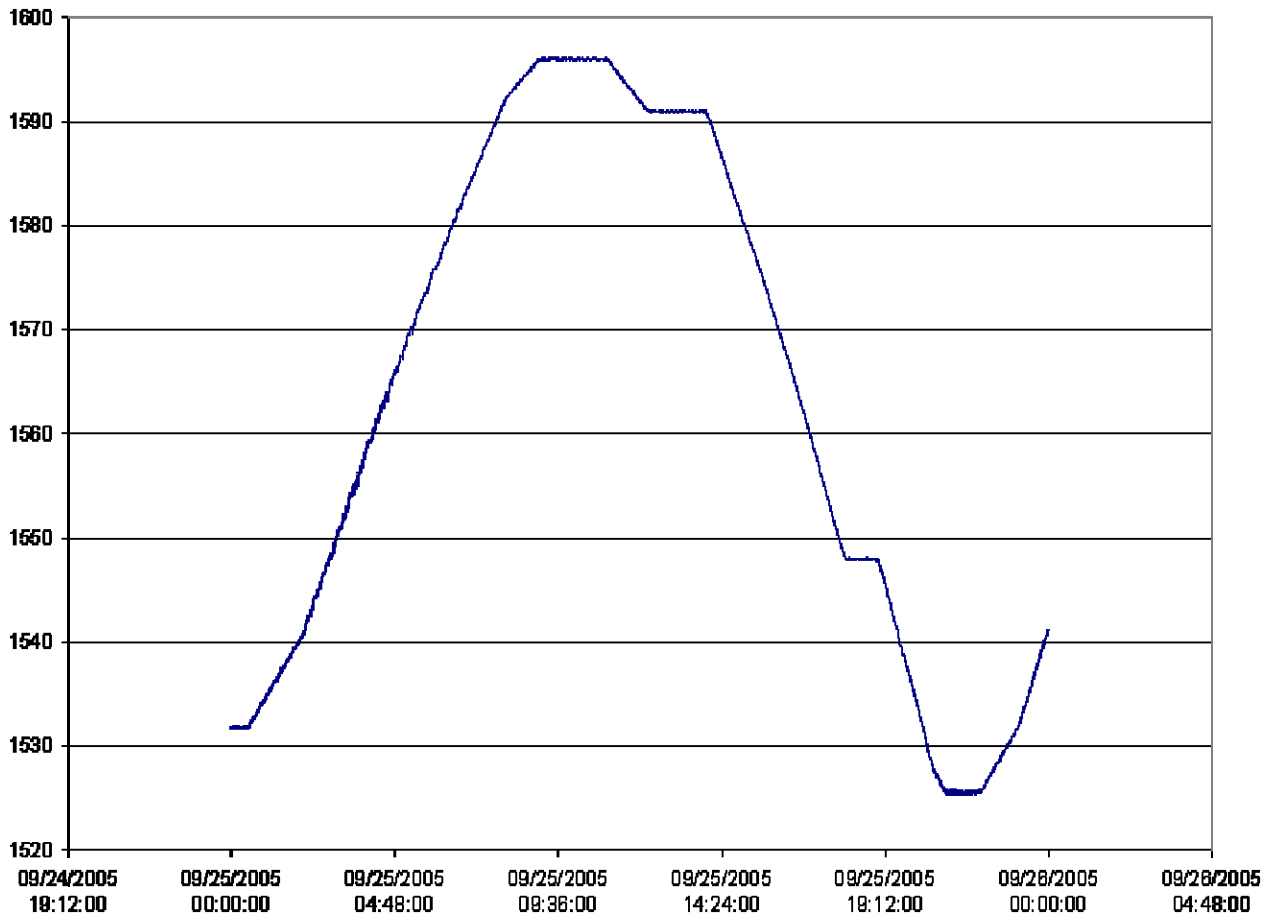

Hurricane Rita Event

Figure 7-9

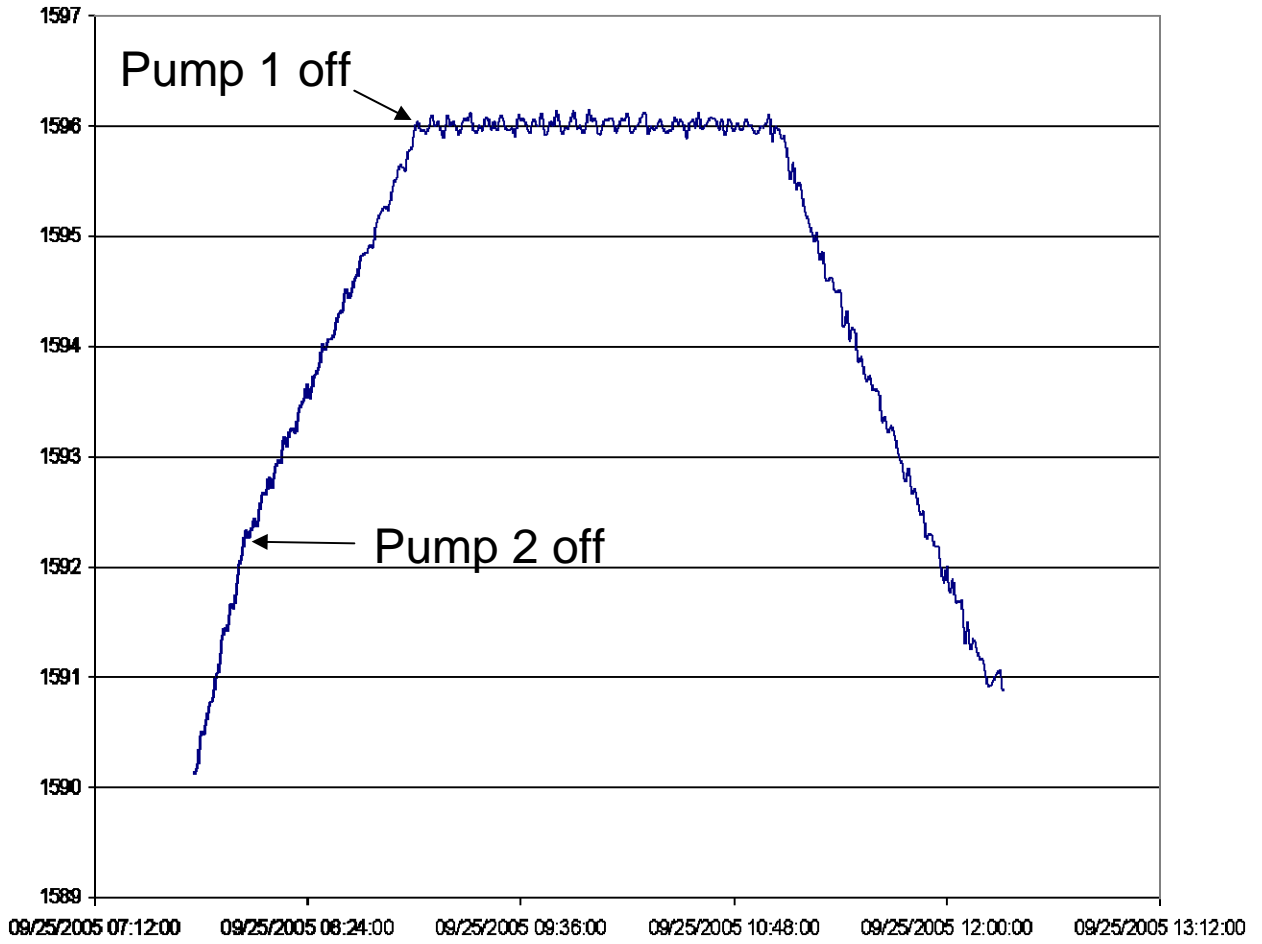

Hurricane Rita Event

Figure 7-10

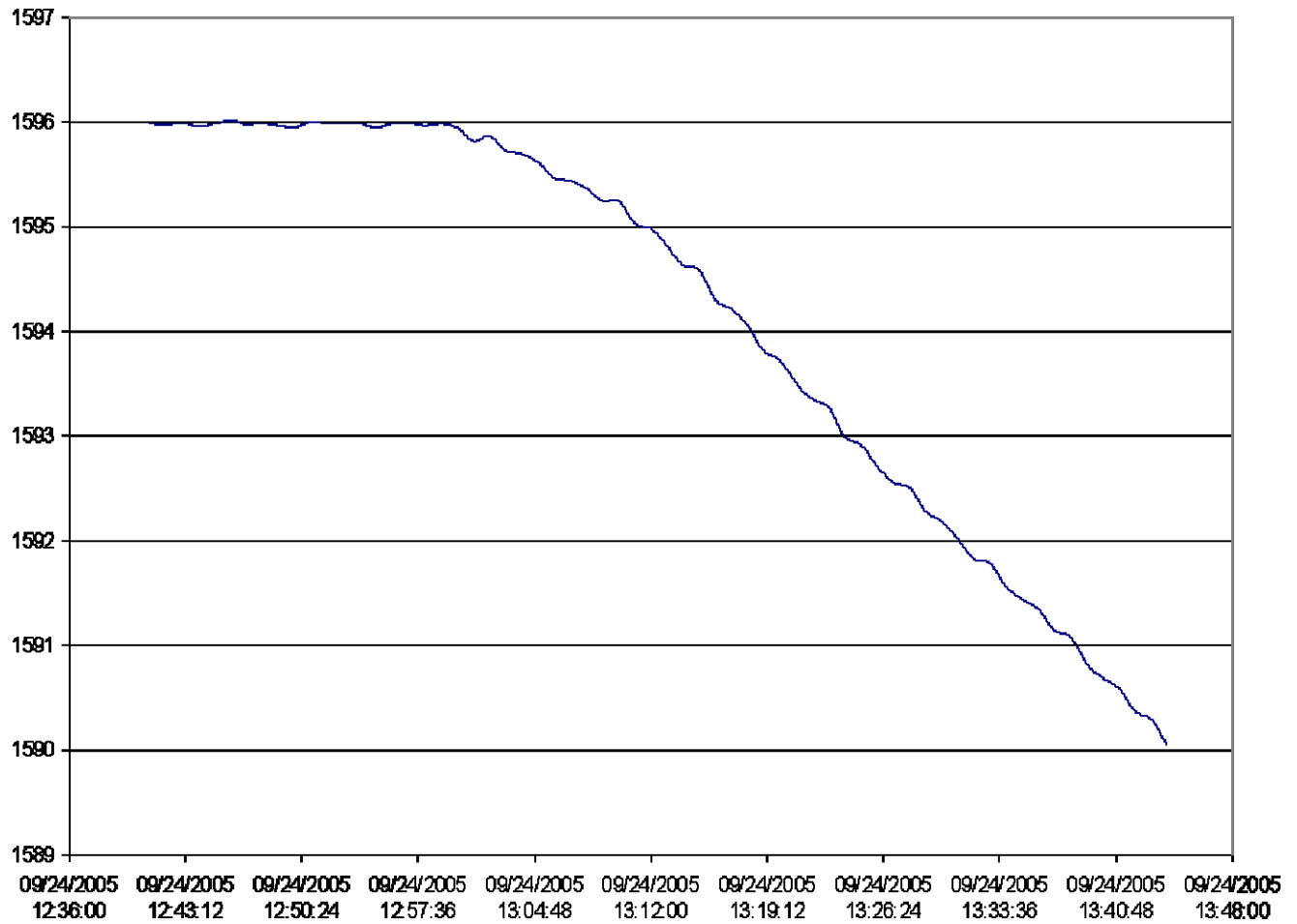

Generation start on day prior to Hurricane Rita. Note smaller level variations compared to next day.

Figure 7-11

Taum Sauk Pump Shutdown Logic

09/27/2005

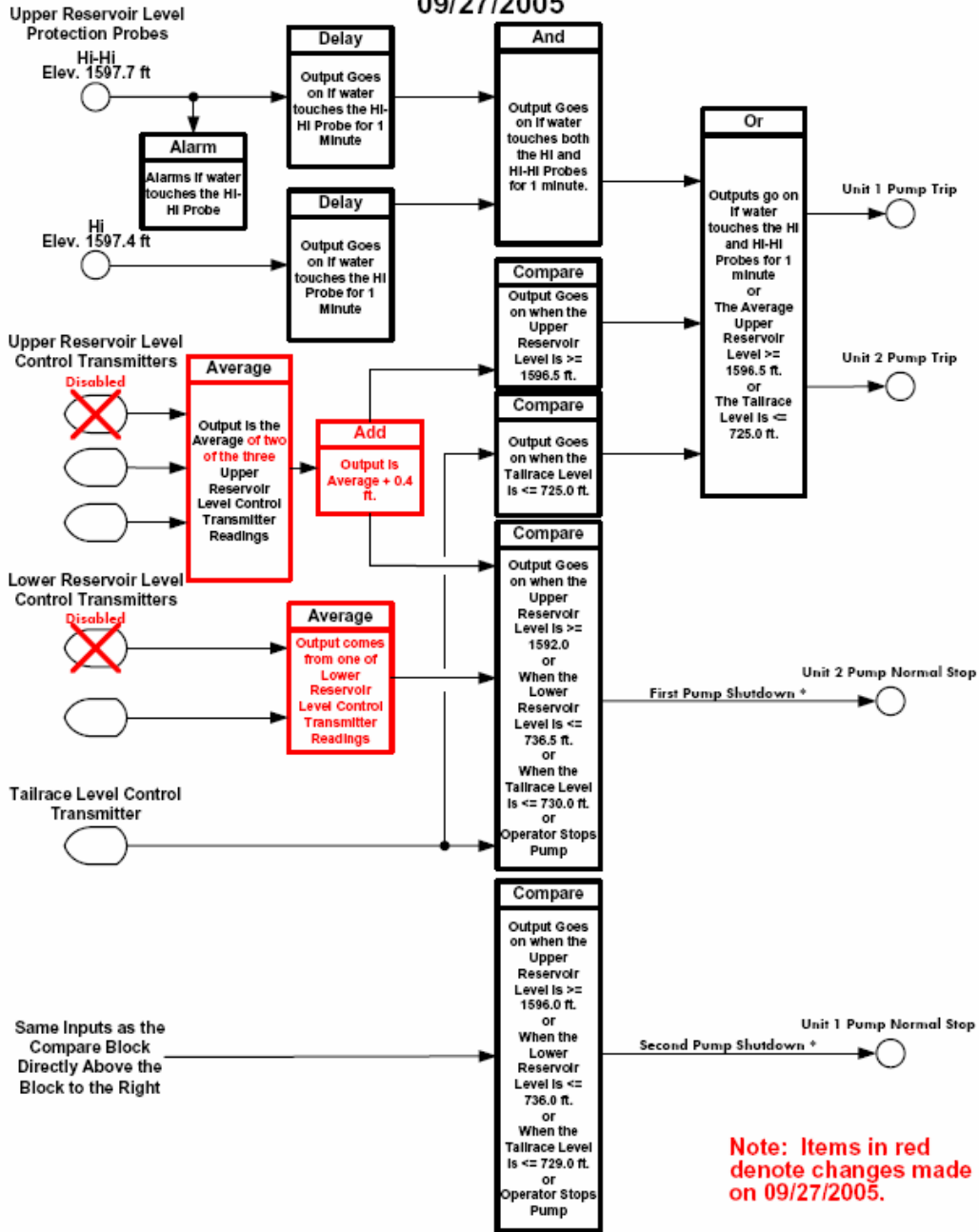

* Pump shutdown order is operator selectable. Logic shows pump order on this date.

Figure 7-12

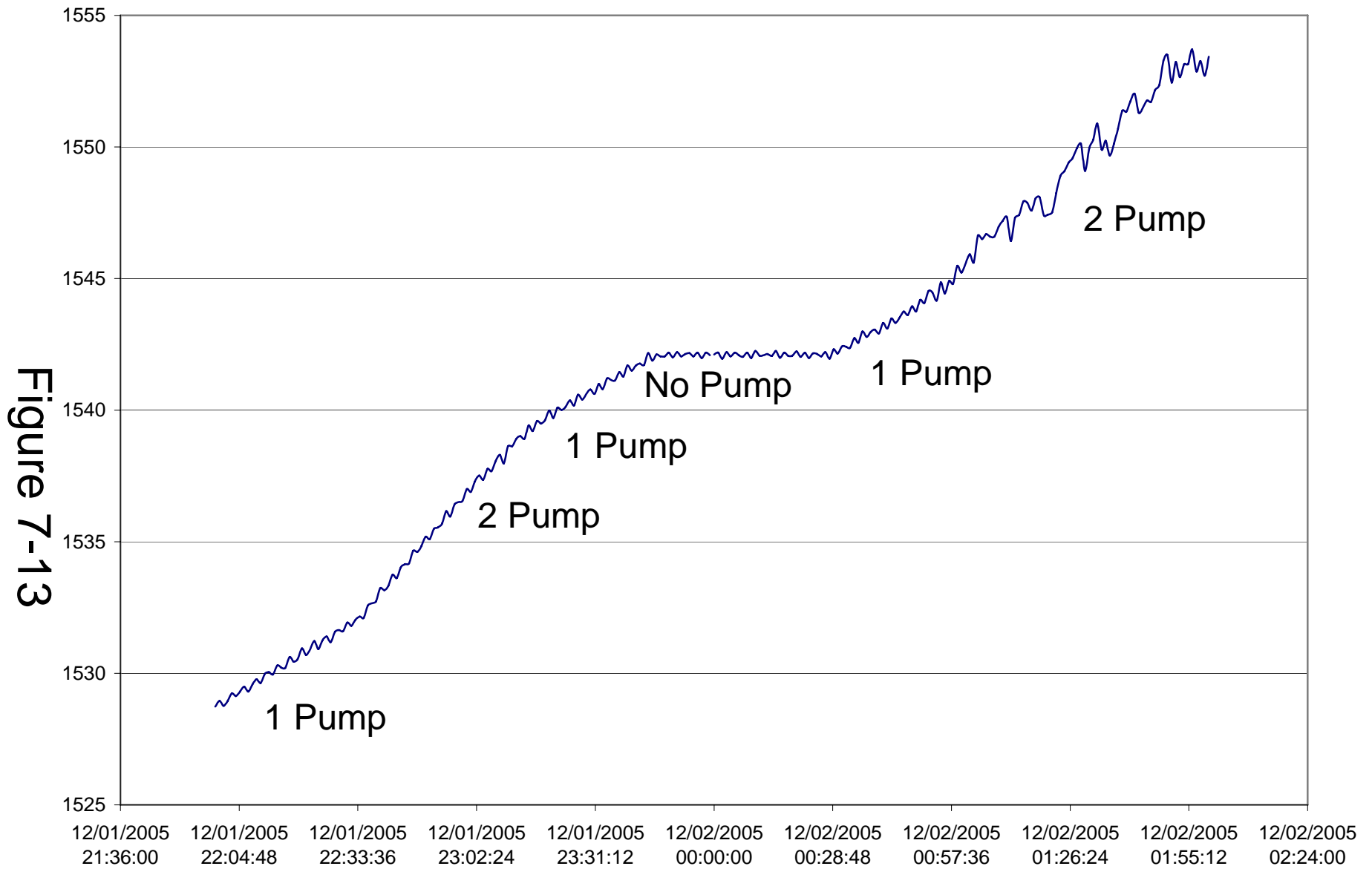

Upper Reservoir Level from Dec. 1st and 2nd.

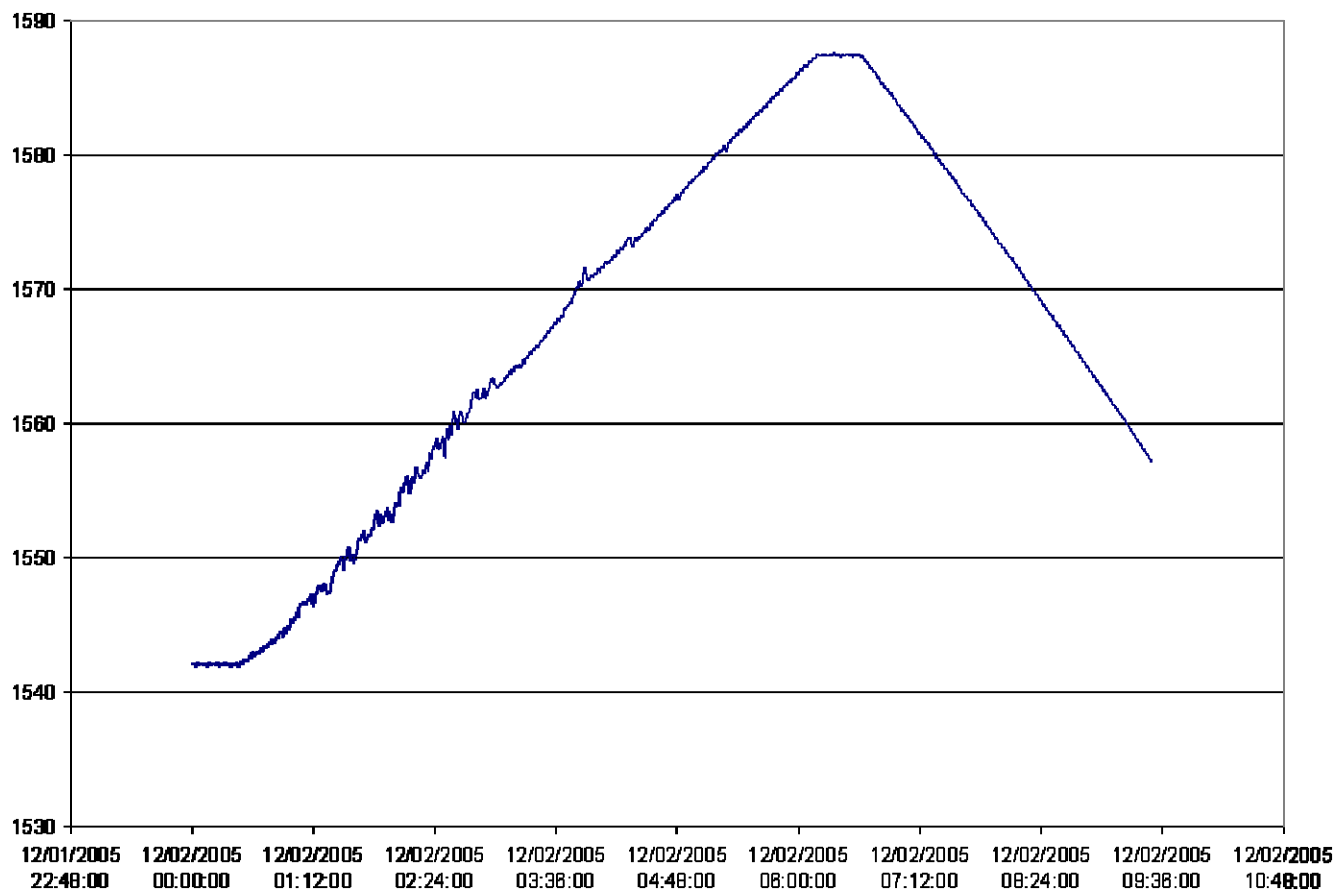

Dec. 2nd. Note erratic behavior on rising and lower level compared to falling level.

Figure 7-14

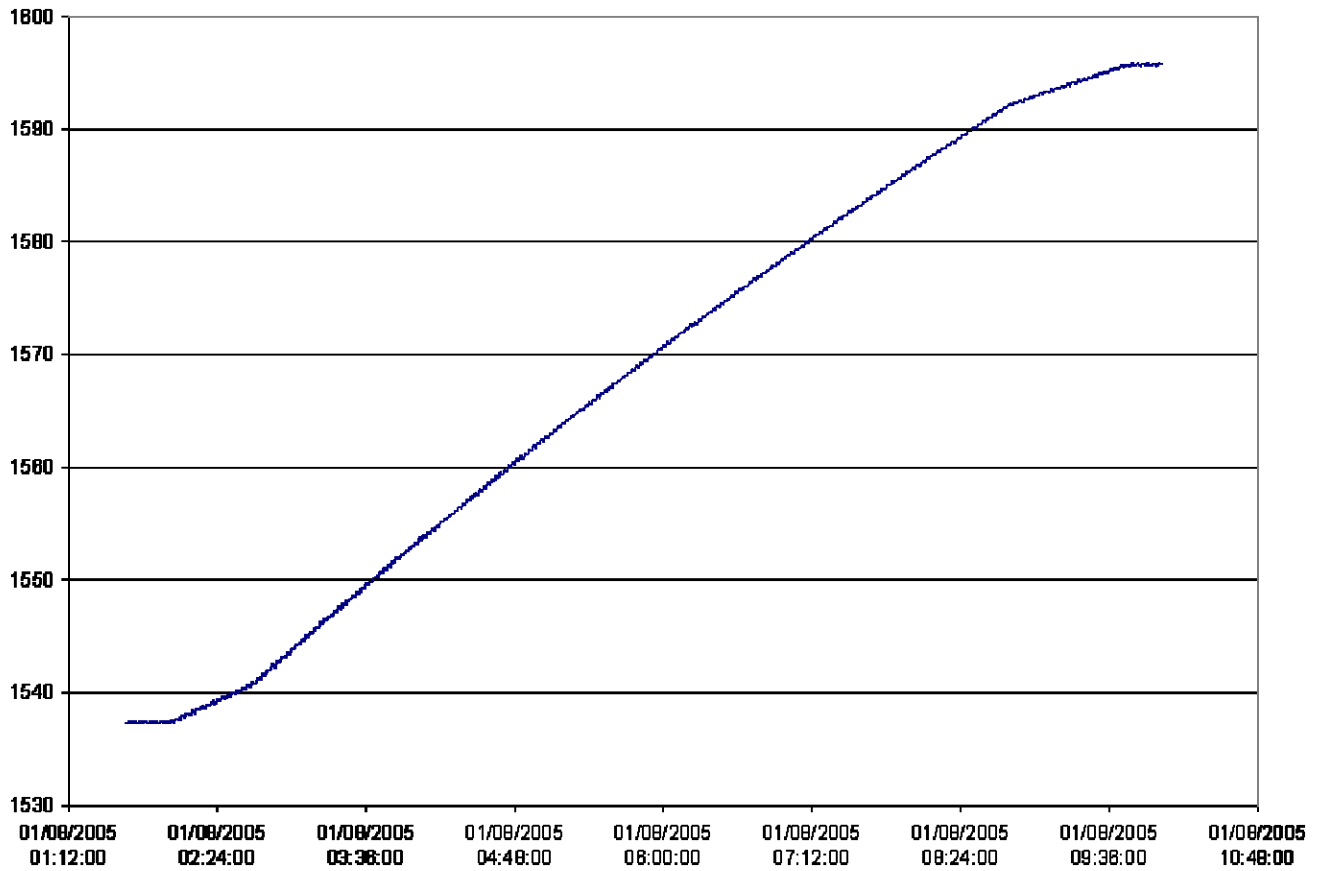

Jan. 2005 two pump operation.

Figure 7-15

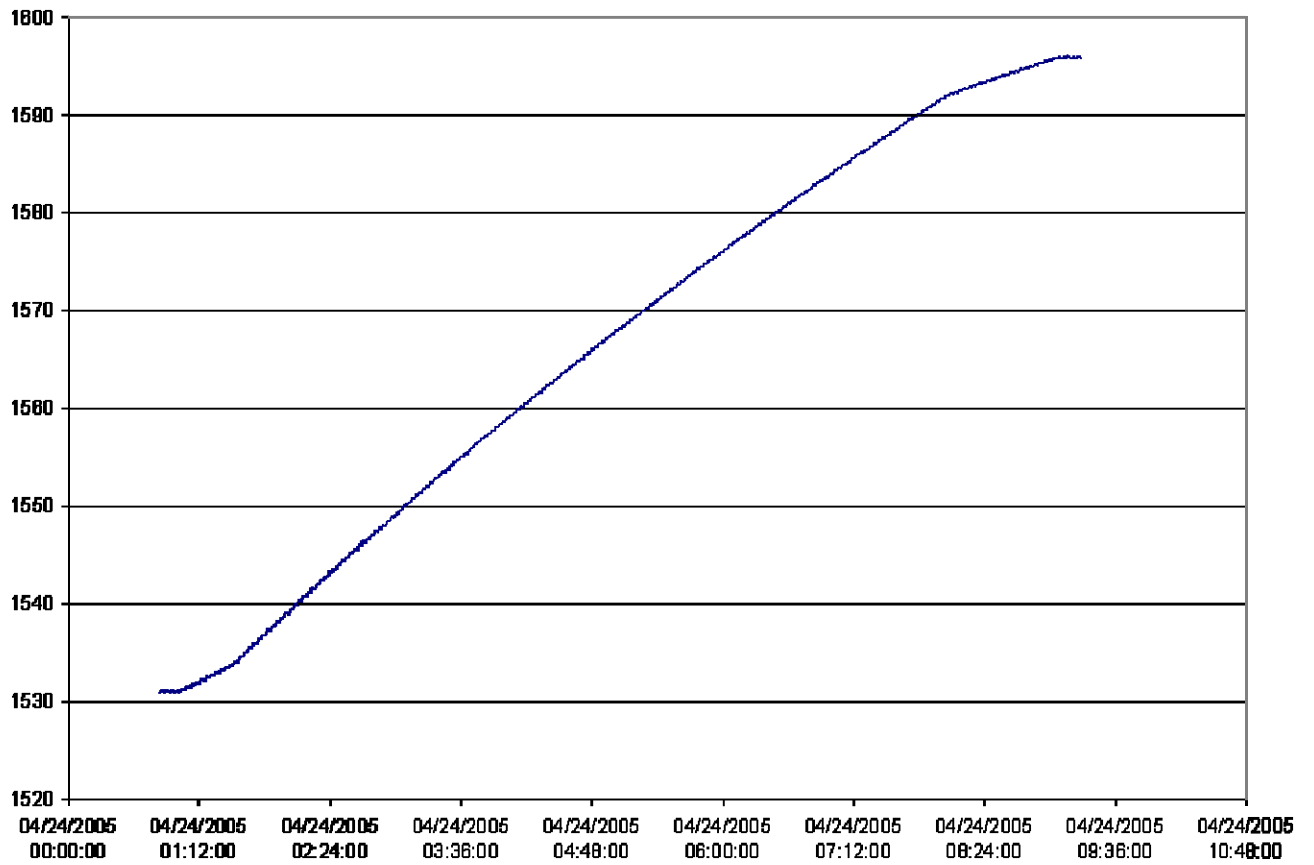

April 2005 two pump operation.

Figure 7-16

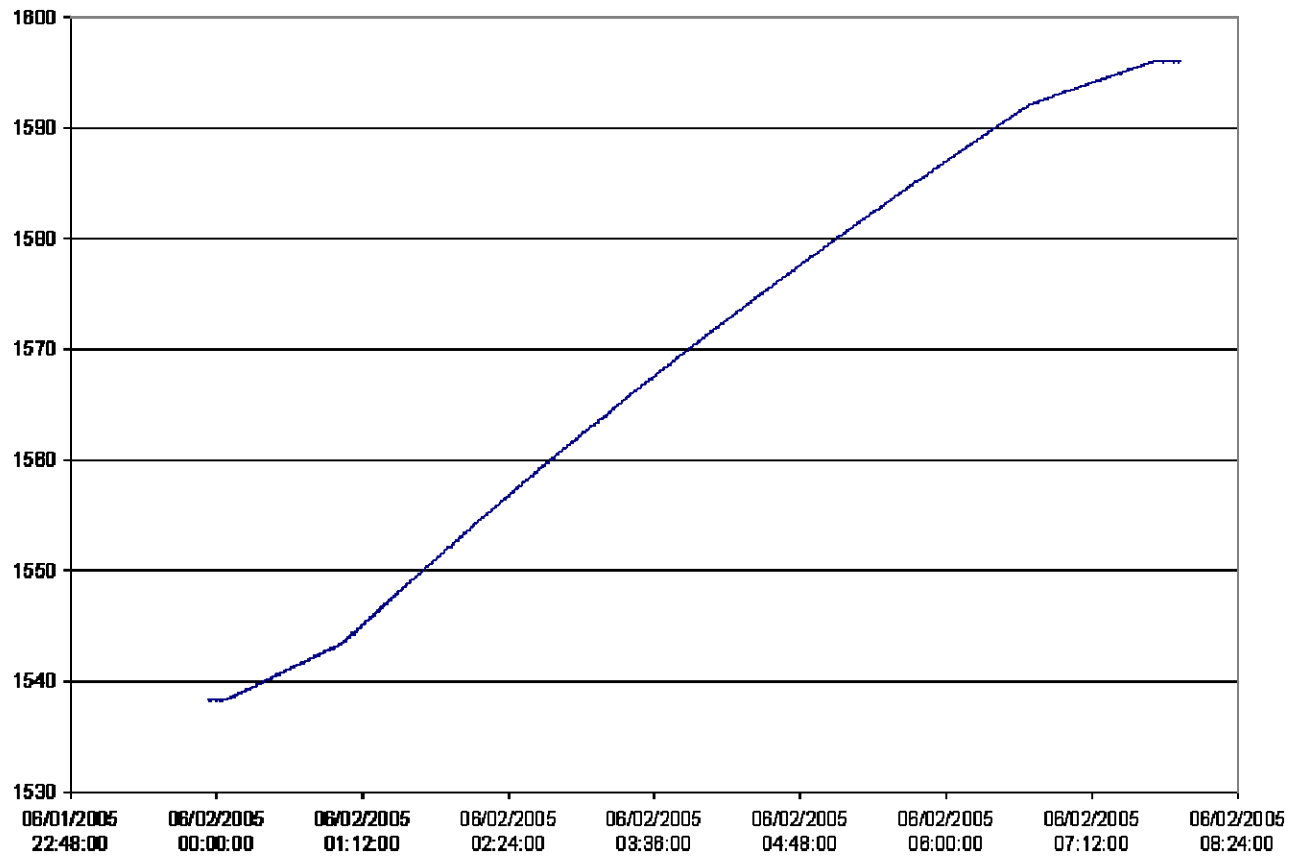

June 2005 two pump operation.

Figure 7-17

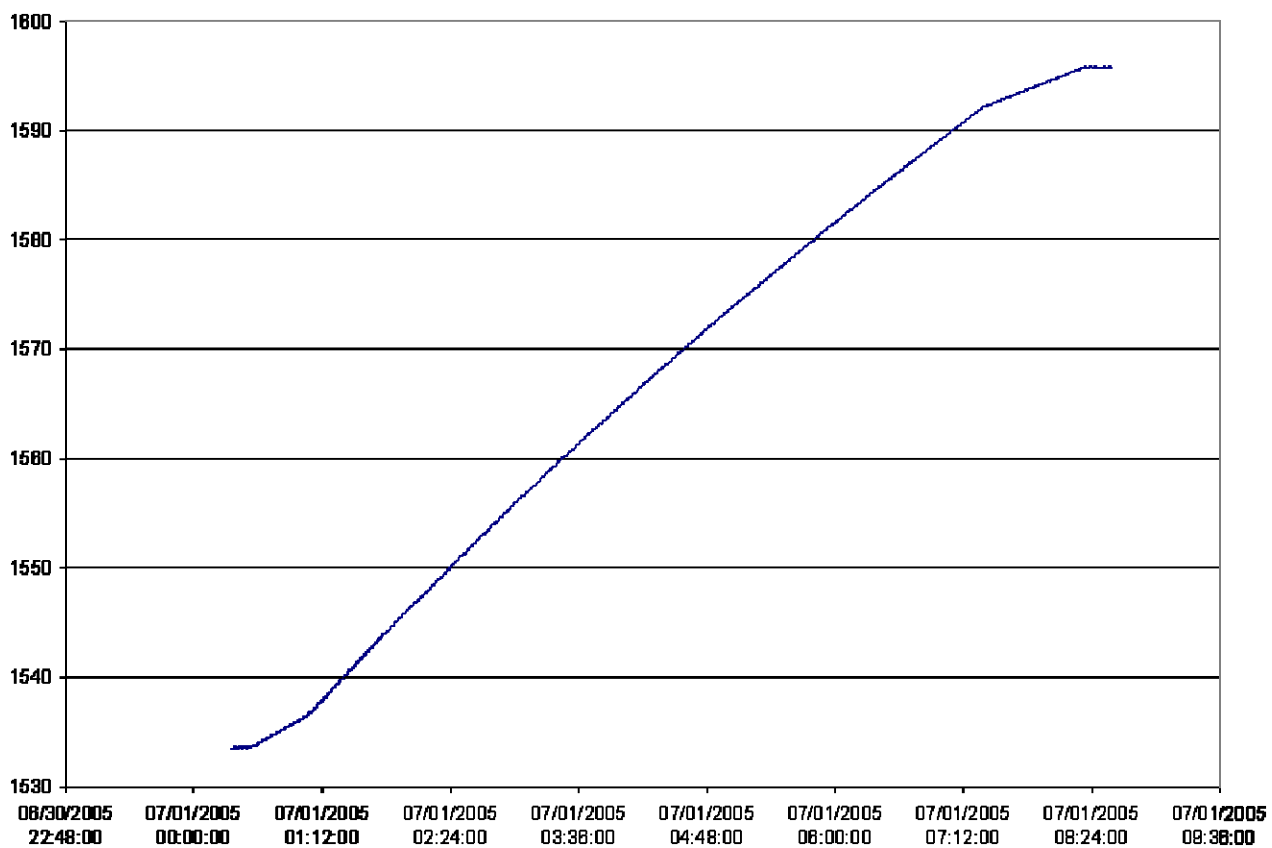

July 2005 two pump operation.

Figure 7-18

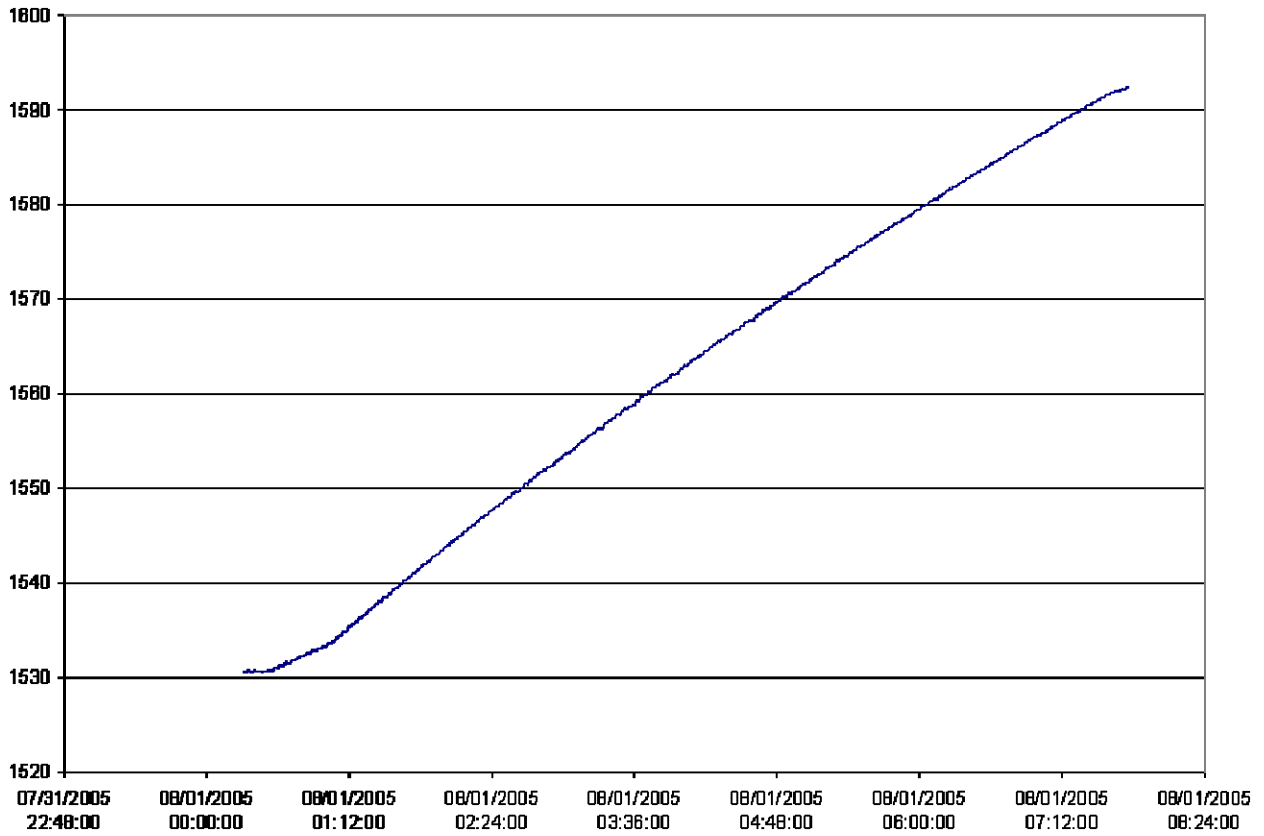

August 1, 2005 two pump operation.

Figure 7-19

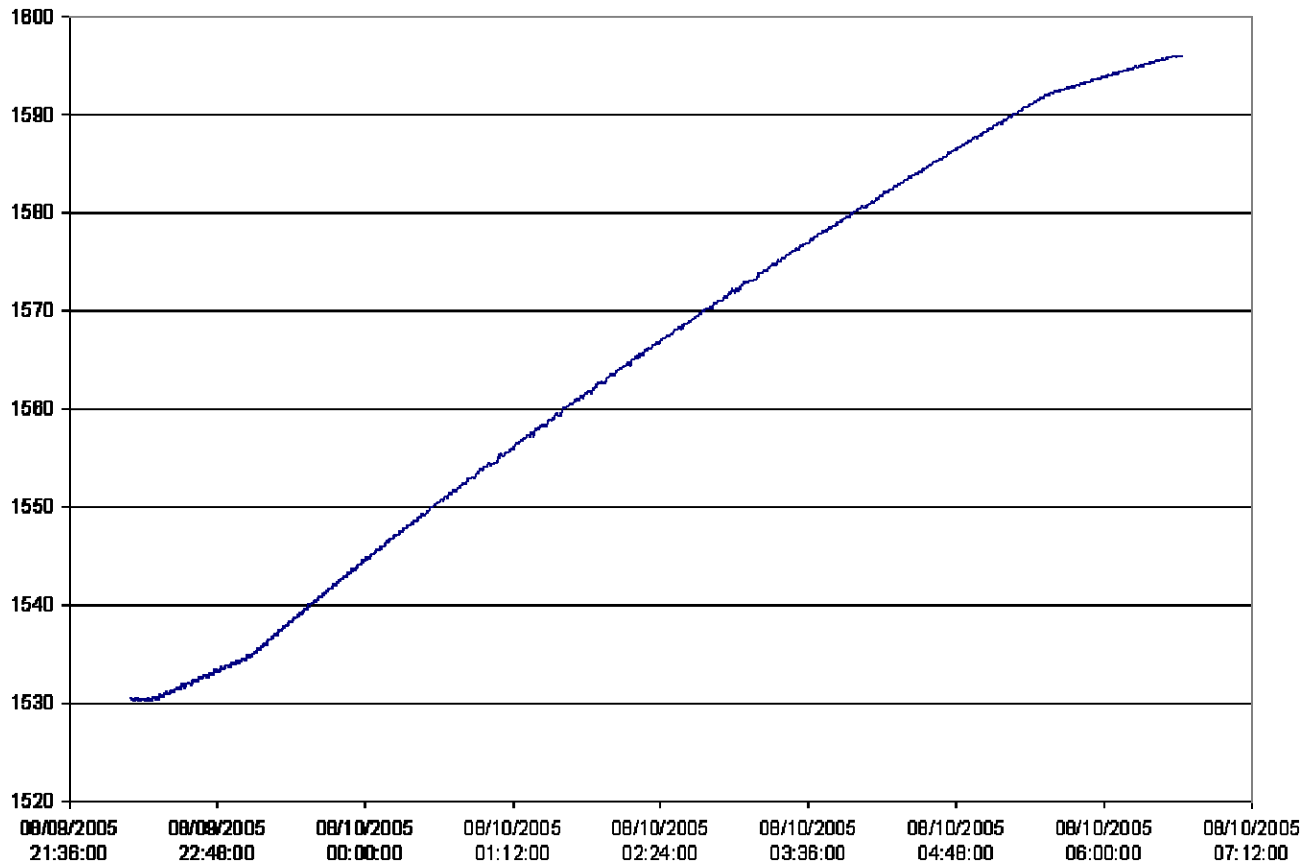

August 10, 2005 two pump operation.

Figure 7-20

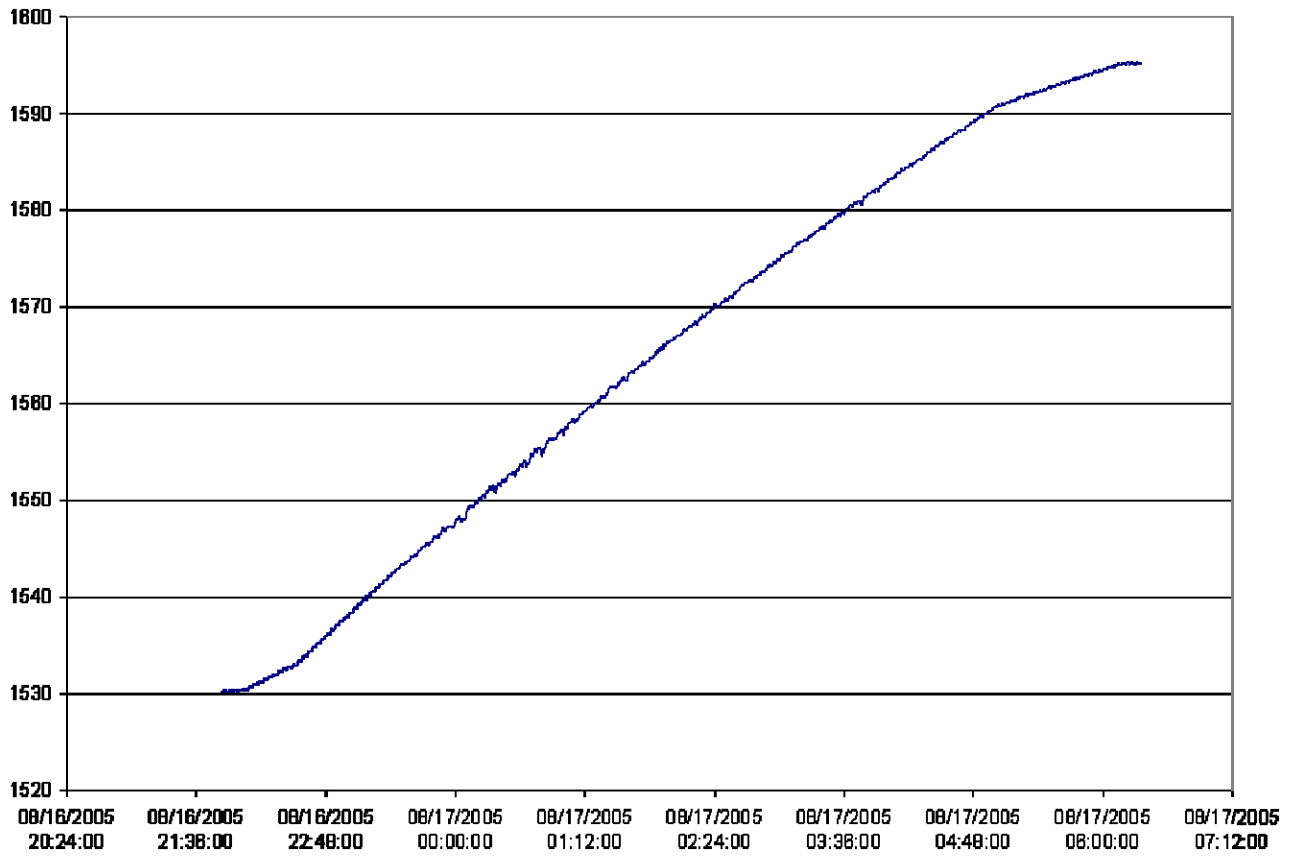

August 17, 2005 two pump operation.

Figure 7-21

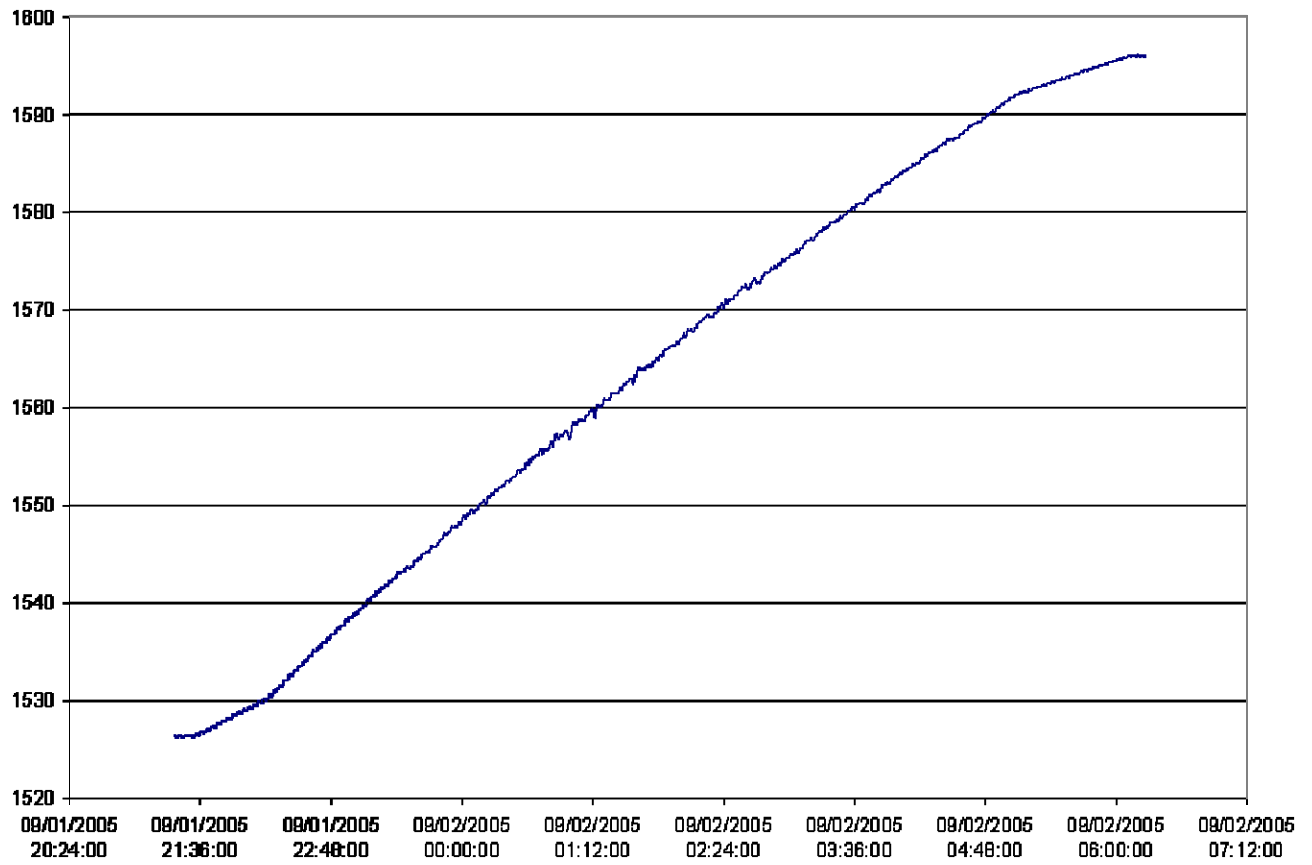

Sept. 2005 two pump operation.

Figure 7-22

Figure 7-23

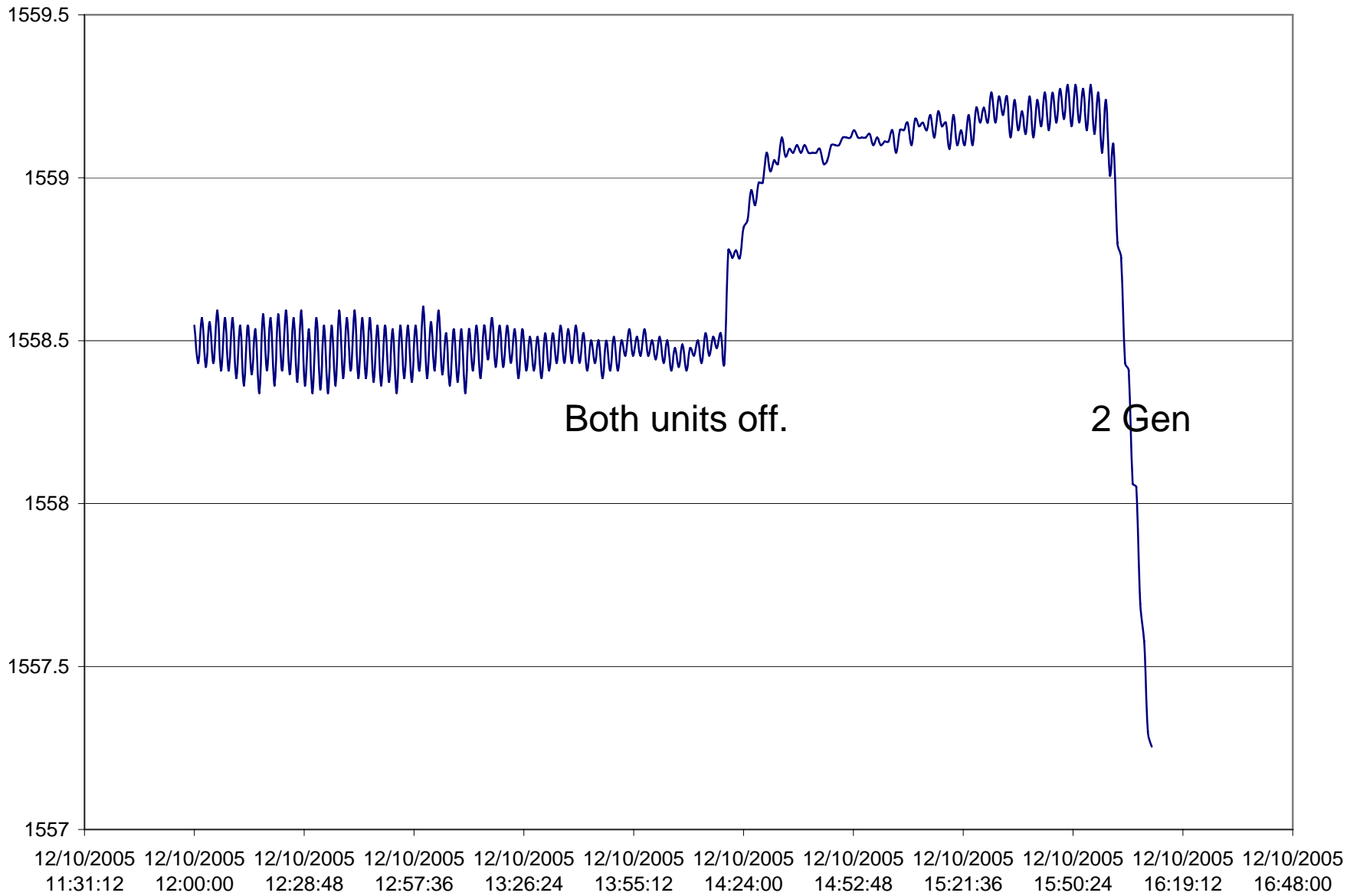

Erratic level indications on Dec. 10th.

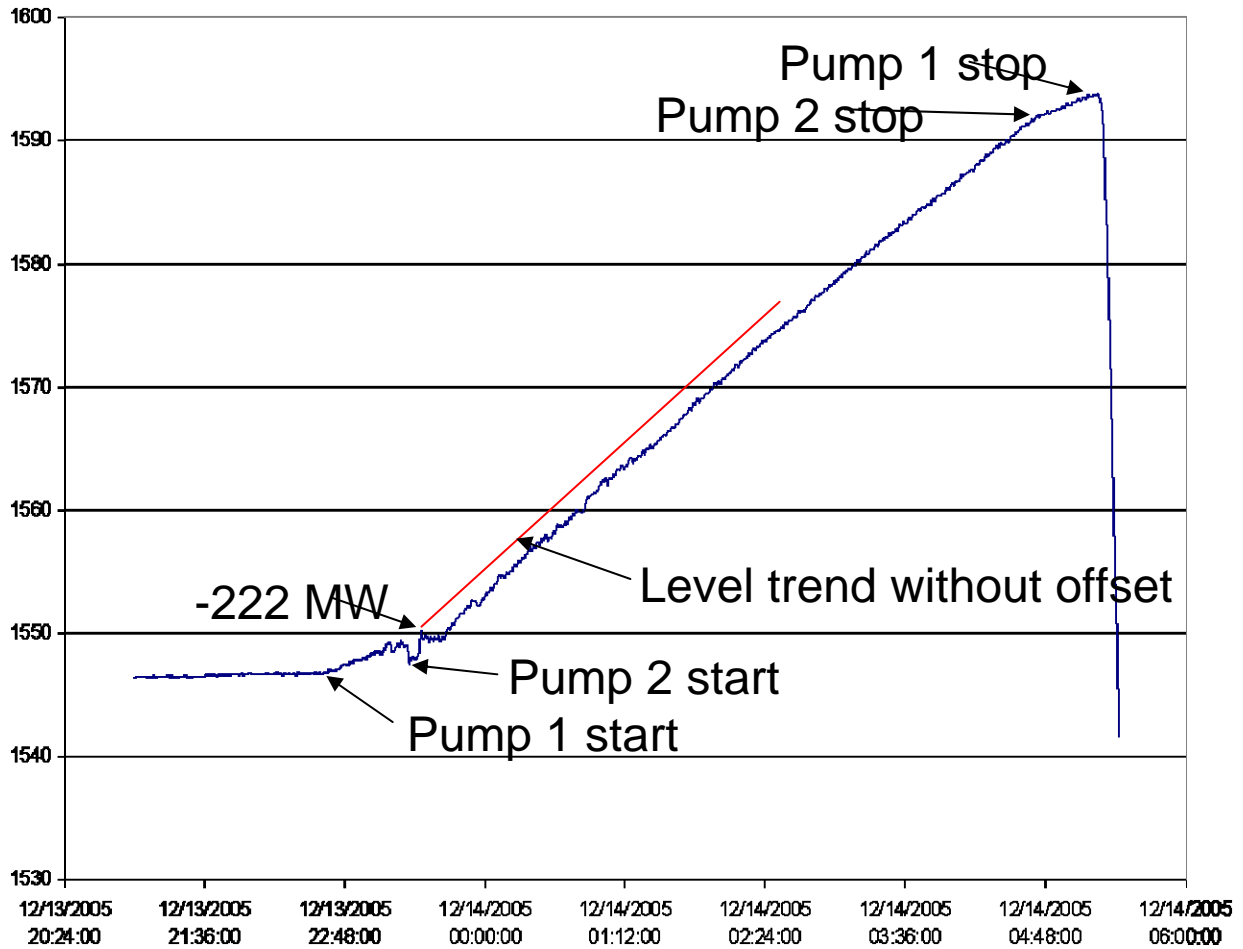

**Level indications after pump 2 start shows an offset.
 -222 MW = Completion of pump 2 start sequence.**

Figure 7-24

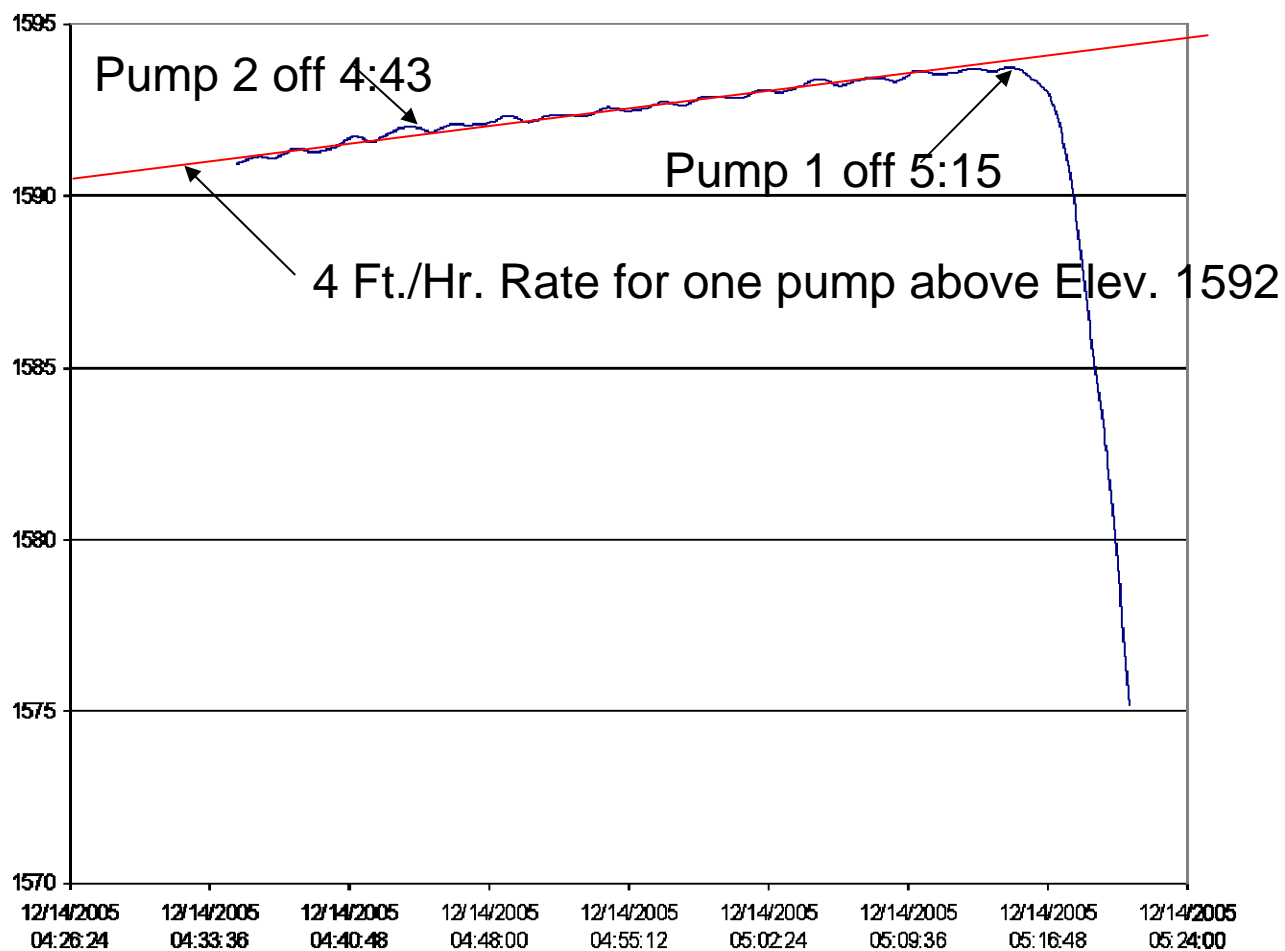

Water level indications at breach event.

Figure 7-25

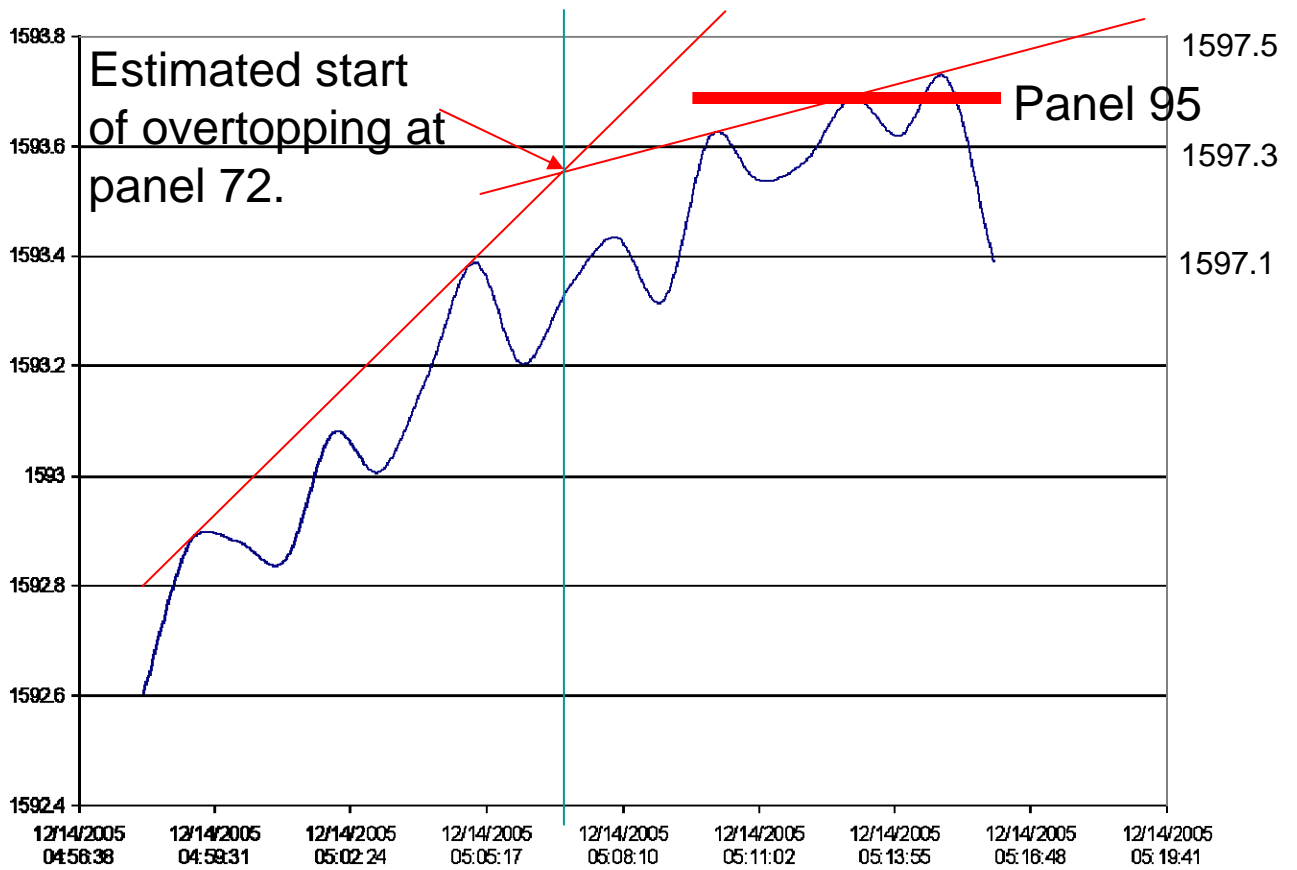

Water level indications (left scale)
and adjusted (right scale) prior to breach event.

Figure 7-26

Figure 7-27

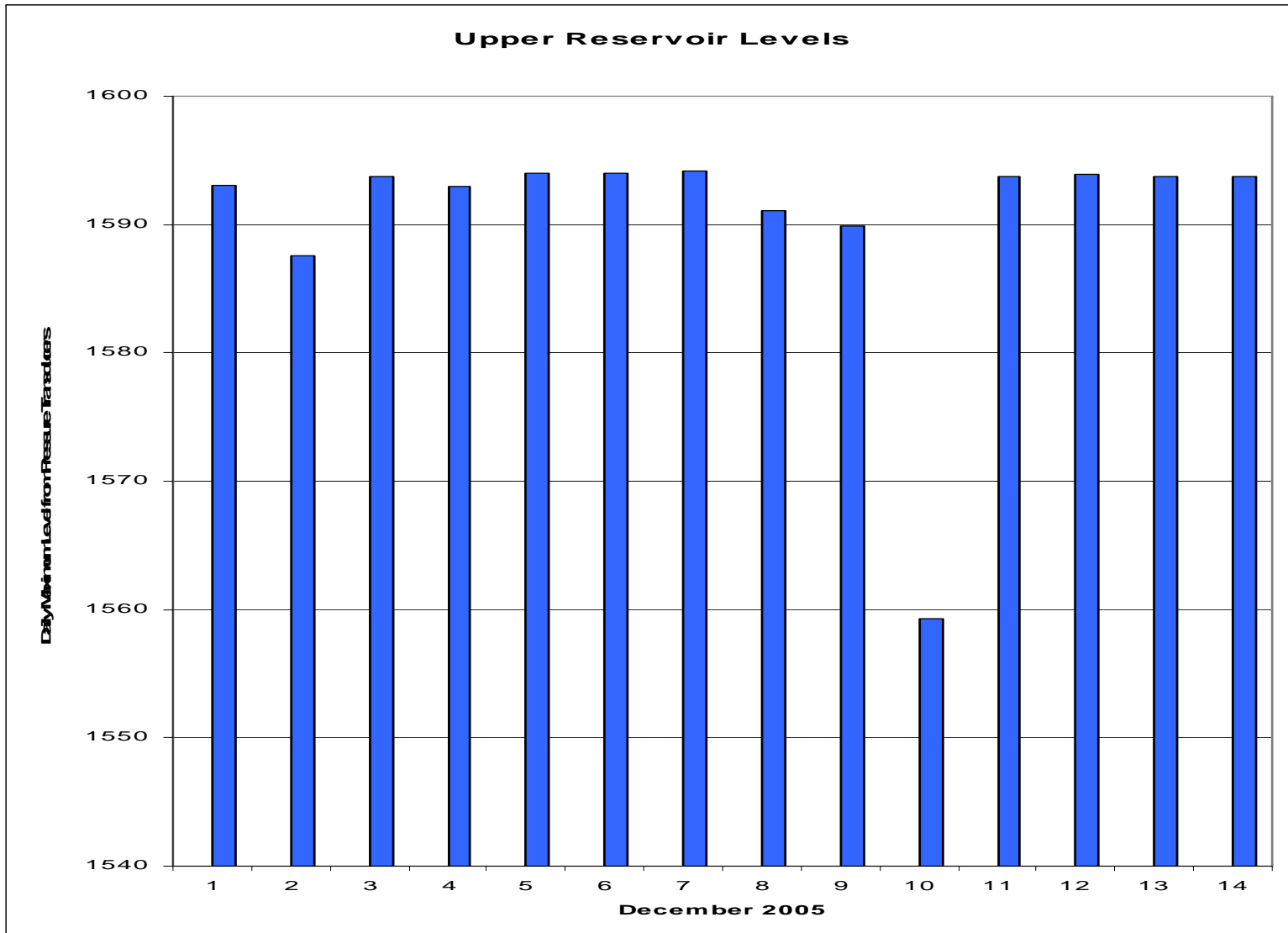

Daily maximum indicated levels.

Figure 7-29

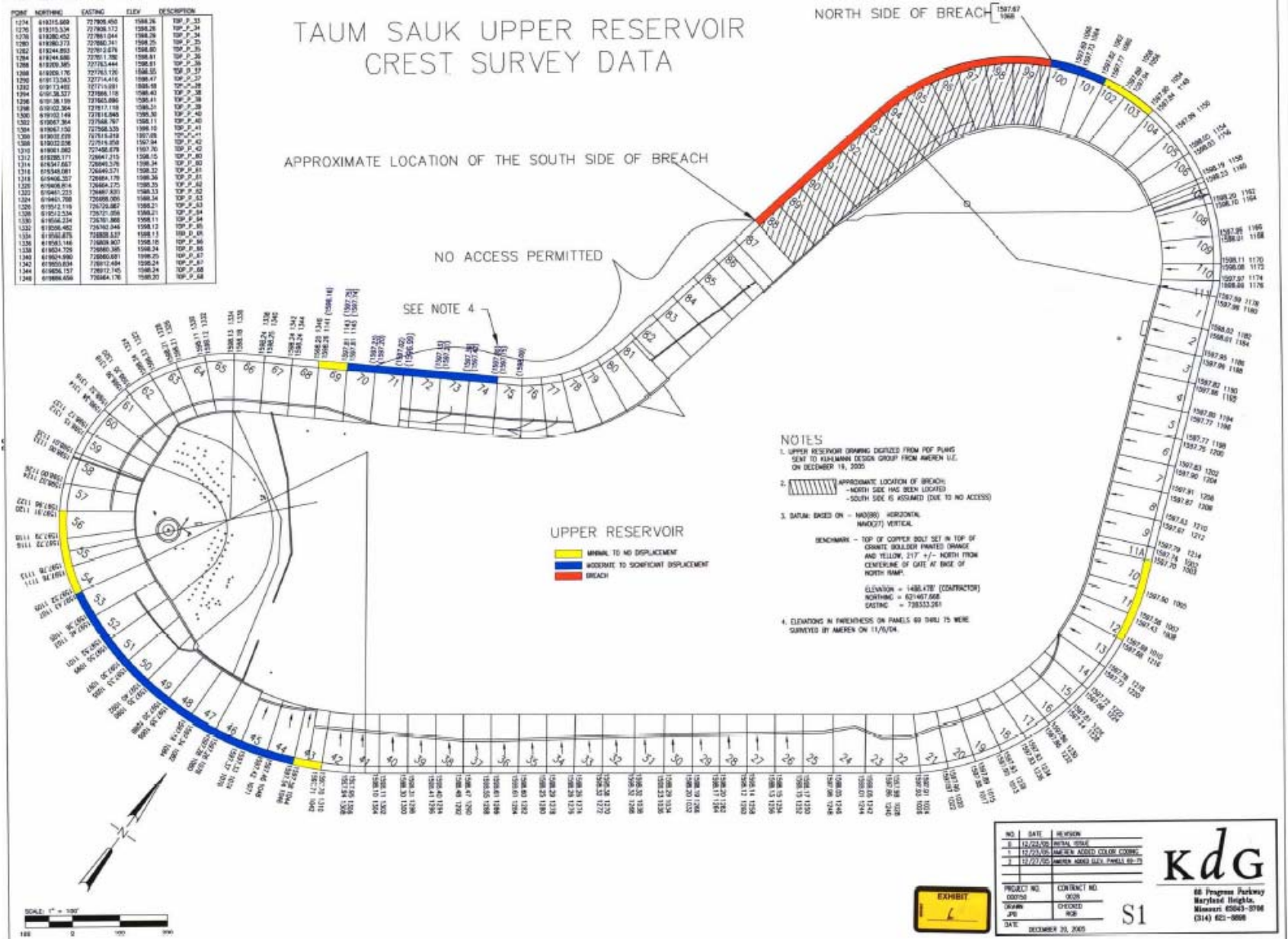
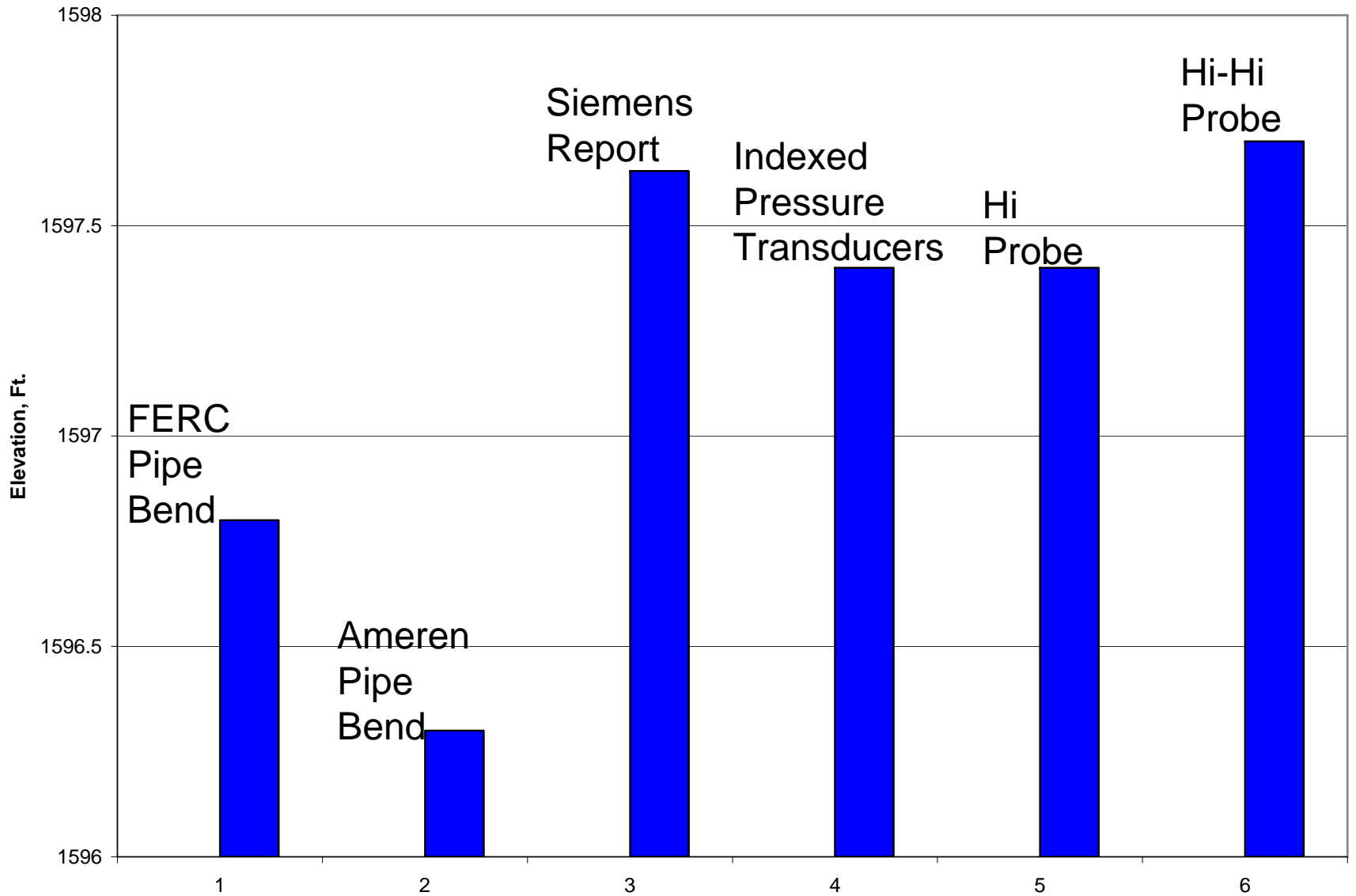
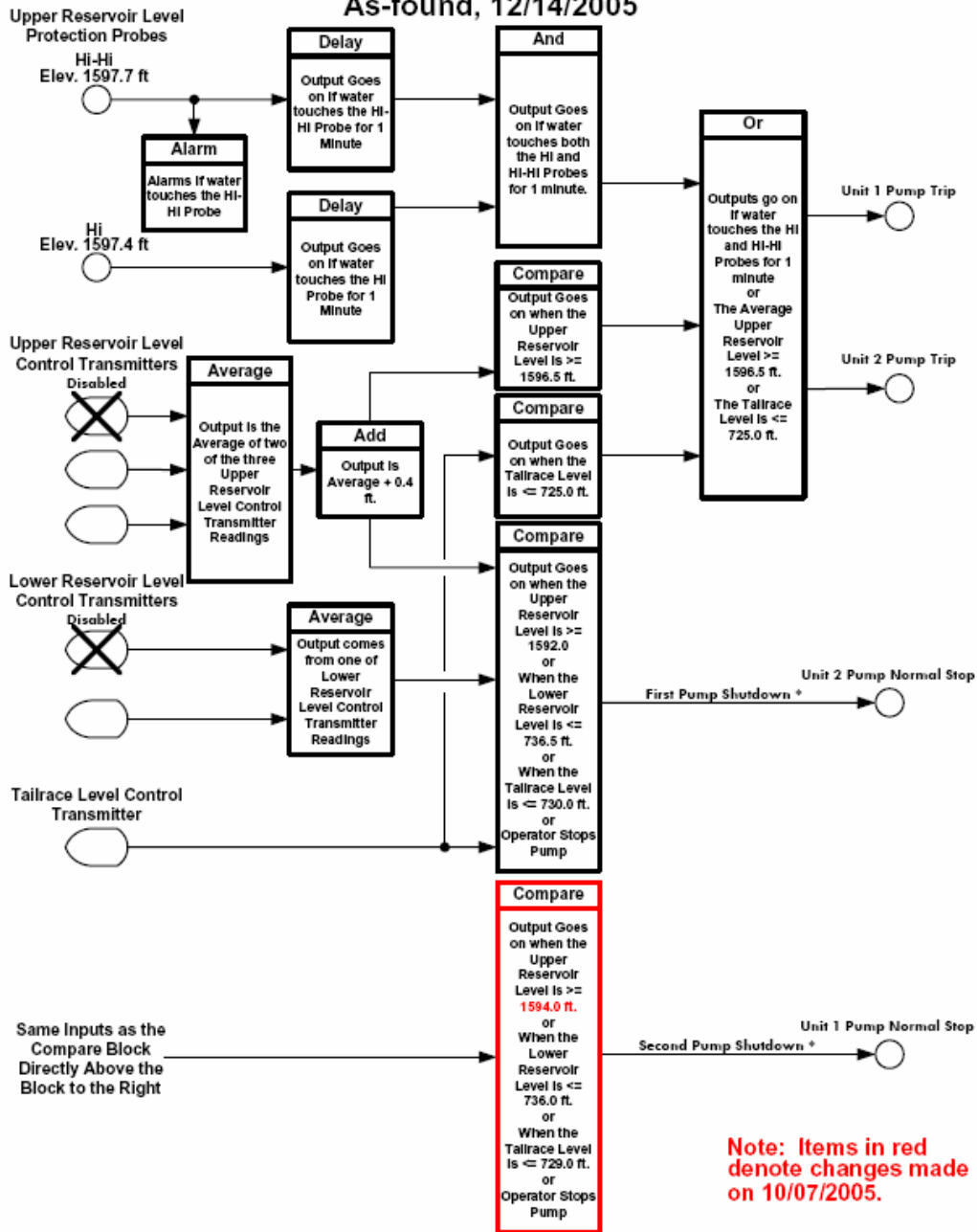

Figure 7-30



Estimates of Maximum Reservoir Level Before Breach

Taum Sauk Pump Shutdown Logic As-found, 12/14/2005



* Pump shutdown order is operator selectable. Logic shows pump order on this date.

Note: Due to programming error made on Sept. 16, 2005, Unit 2 pump shutdown due to level protection probe response was disabled.

Figure 7-31

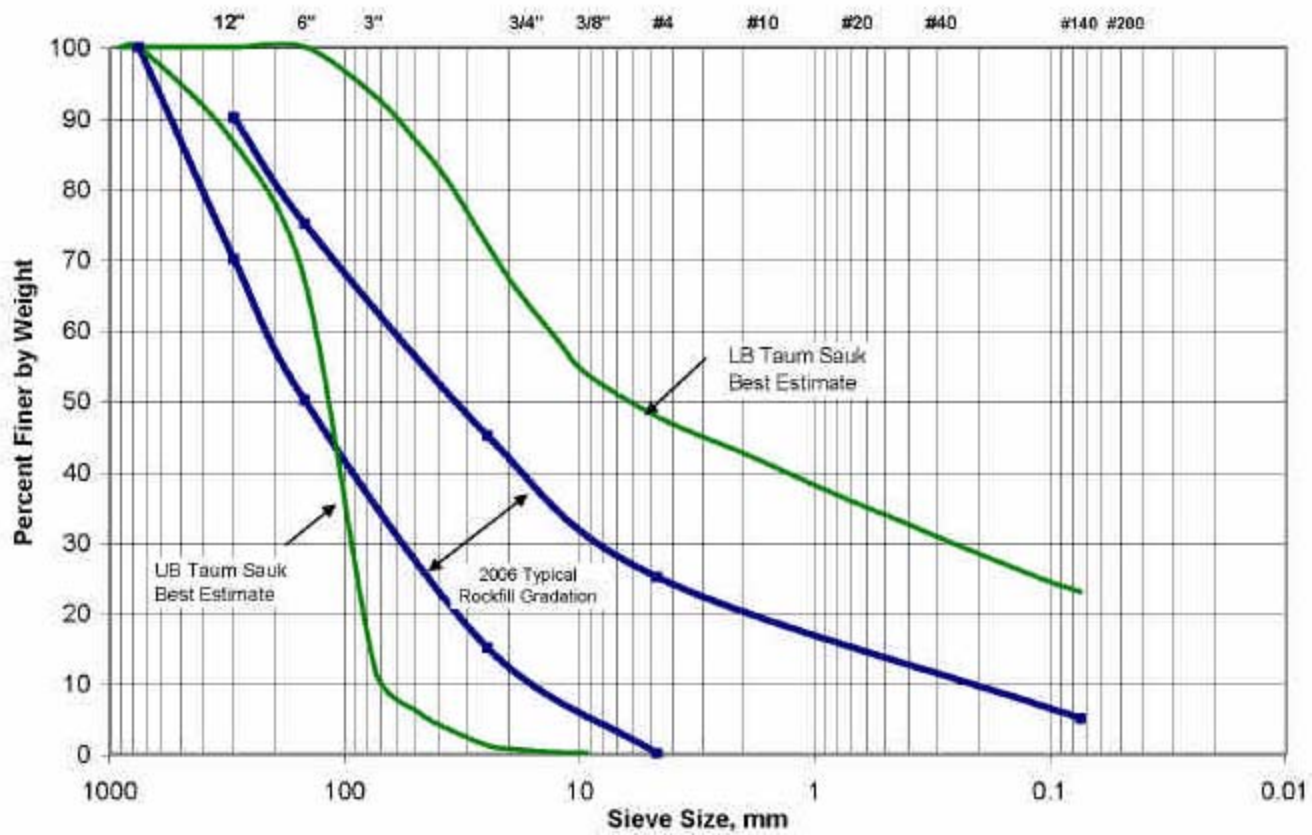

BEST ESTIMATE OF ROCKFILL GRADATION

Figure 7-32